

# Robotic Welding

PRODUCT CATALOGUE

2020





# Contents

Globally local **6**

---

K-Levels **8**

---

Introduction to Kemppi robotic offering **11**

---

Wise products **12**

---

Introduction \_\_\_\_\_ 13

WiseFusion \_\_\_\_\_ 14

WisePenetration \_\_\_\_\_ 15

WiseThin \_\_\_\_\_ 16

WiseRoot \_\_\_\_\_ 17

RGT \_\_\_\_\_ 18



**A7 MIG Welder **20****

---

System overview \_\_\_\_\_ 21

A7 Power Source 350 / 450 \_\_\_\_\_ 22

A7 Wire Feeder 25 \_\_\_\_\_ 23

Wire feed roll kits \_\_\_\_\_ 24

Water cooling unit \_\_\_\_\_ 25

Robot interface module \_\_\_\_\_ 26

Interconnection cables \_\_\_\_\_ 26

Interconnection cable brackets \_\_\_\_\_ 27

Earth return cable \_\_\_\_\_ 28

Wire conduit for wire spools \_\_\_\_\_ 28

Wire conduit for wire drums \_\_\_\_\_ 29

Wire spool holder \_\_\_\_\_ 30

Protective cover for wire spool \_\_\_\_\_ 30

Floor stand for wire spool holder \_\_\_\_\_ 30

Wire feeder mounting brackets \_\_\_\_\_ 31



Wise processes	32
Welding Gun package	32
Welding Gun cleaning station	32
Mounting kit A7 dual feeder	33



## **KempArc Pulse 34**

System overview	35
KempArc Pulse 350 / 450 power source	36
KempArc DT400 / DT400L / DT410L wire feeder	37
Feed roll kits for DT400 wire feeder	38
Kempcool 10 cooling unit	39
Robot interface cards	40
Interconnection cables	40
Interconnection cable brackets	41
Earth return cable	42
Wire conduit for wire spools	42
Wire conduit for wire drums	43
Wire spool holder	44
Protective cover for wire spool	44
Floor stand for wire spool holder	44
Wire feeder mounting brackets	45
Wise processes	46
Welding Gun package	46
Welding Gun cleaning station	46
Remote control panel	47
Gas flow kit	47



## KempArc Synergic

**48**

---

System overview	49
KempArc SYN 500 power source	50
KempArc DT400 / DT400L / DT410L wire feeder	51
Feed roll kits for DT400 wire feeder	52
Kempcool 10 cooling unit	53
Robot interface cards	54
Interconnection cables	55
Interconnection cable brackets	56
Earth return cable	56
Wire conduit for wire spools	57
Wire conduit for wire drums	58
Wire spool holder	59
Protective cover for wire spool	59
Floor stand for wire spool holder	59
Wire feeder mounting brackets	60
Wise processes	61
Welding Gun package	61
Welding Gun cleaning station	61
Gas flow kit	61



## Robotic Gun packages

**62**

---

Overview	63
Gun mounts	64
Adapter flanges	66
Cable assemblies	69
Wire liners	76
Contact tip holders	77



Welding gun necks	78
Gas nozzles	80
Accessories	84
Robotic gun cleaning station	86
Consumables for gun cleaning station	87
<b>Example set ups</b>	<b>88</b>
<b>Contact information</b>	<b>93</b>

# Kemppi

## Globally local

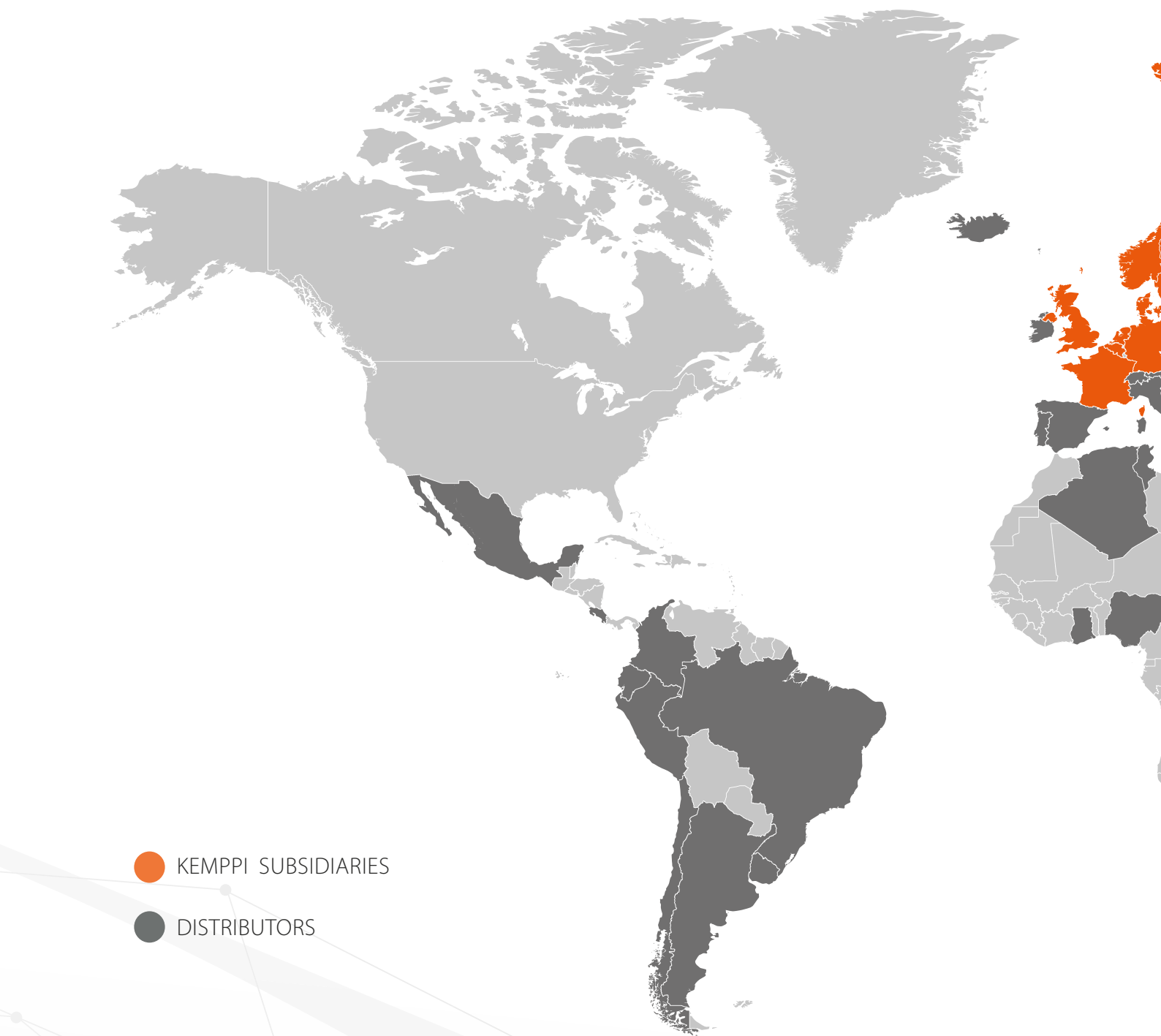

● KEMPPI SUBSIDIARIES

● DISTRIBUTORS

Kemppi business operates globally. The company headquarters and main production units are located in Finland. Kemppi sales organisations are established in Finland, Sweden, Norway, Denmark, Germany, France, United Kingdom, Netherlands, Poland, Russia, Australia, India and China. Kemppi also has representatives in more than 60 countries, responsible for country based product distribution, sales and customer service.

For a full list of Kemppi sales companies, distributors and dealers, visit [www.kemppi.com](http://www.kemppi.com)

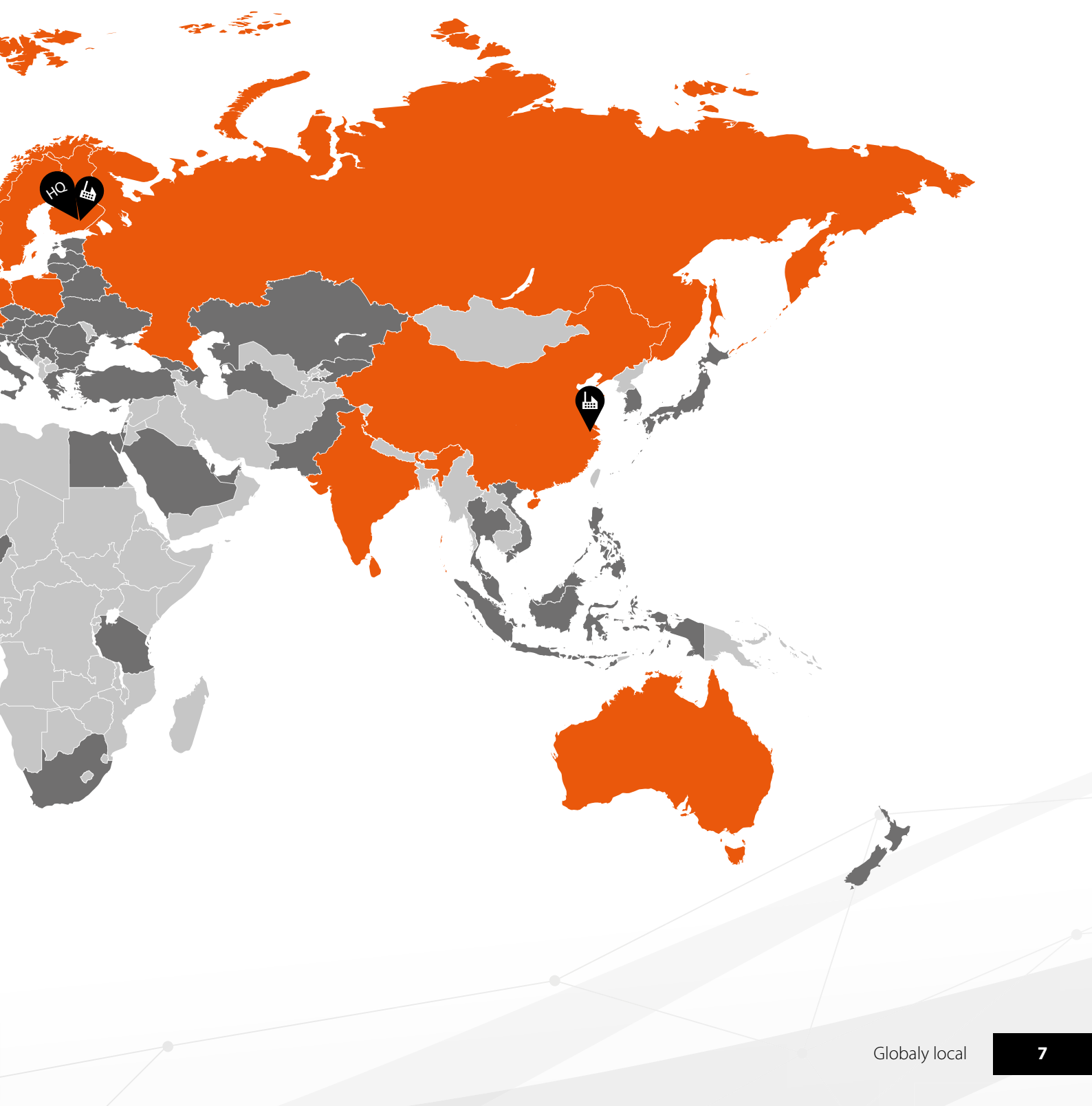







# Kemppi value levels

**No matter your need, there is always a Kemppi solution for you.** Our welding equipment is divided into value levels - K8, K7, K5 and K3 - in order to provide you with the most suitable equipment for your purposes. The higher the value level, the more features and functions you get in terms of performance, usability and modern connectivity.



## K8 value level

With the K8 value level equipment we are creating tomorrow's welding today. Thanks to smart welding innovations, groundbreaking usability, and full connectivity, the K8 equipment lets you to perform, control and manage the welding production in a way that was not possible before.



## K7 value level

The Kemppi K7 value level elevates the welding equipment to a whole new level of performance and intelligence. It offers a unique combination of refined control, advanced welding features, usability, and connectivity.



## K5 value level

Kemppi's value level K5 equipment sets new standards for welding. Thanks to their uncompromised design, they convincingly meet all the expectations that are placed on the equipment of their class: versatility, ease of use, and application optimized performance with state-of-the-art technology.



## K3 value level

Kemppi's K3 value level equipment features everything that Kemppi stands for - solid build quality and performance without compromises. K3 equipment provides fabricators with a smart investment route to increase efficiency and quality in a wide variety of welding jobs.

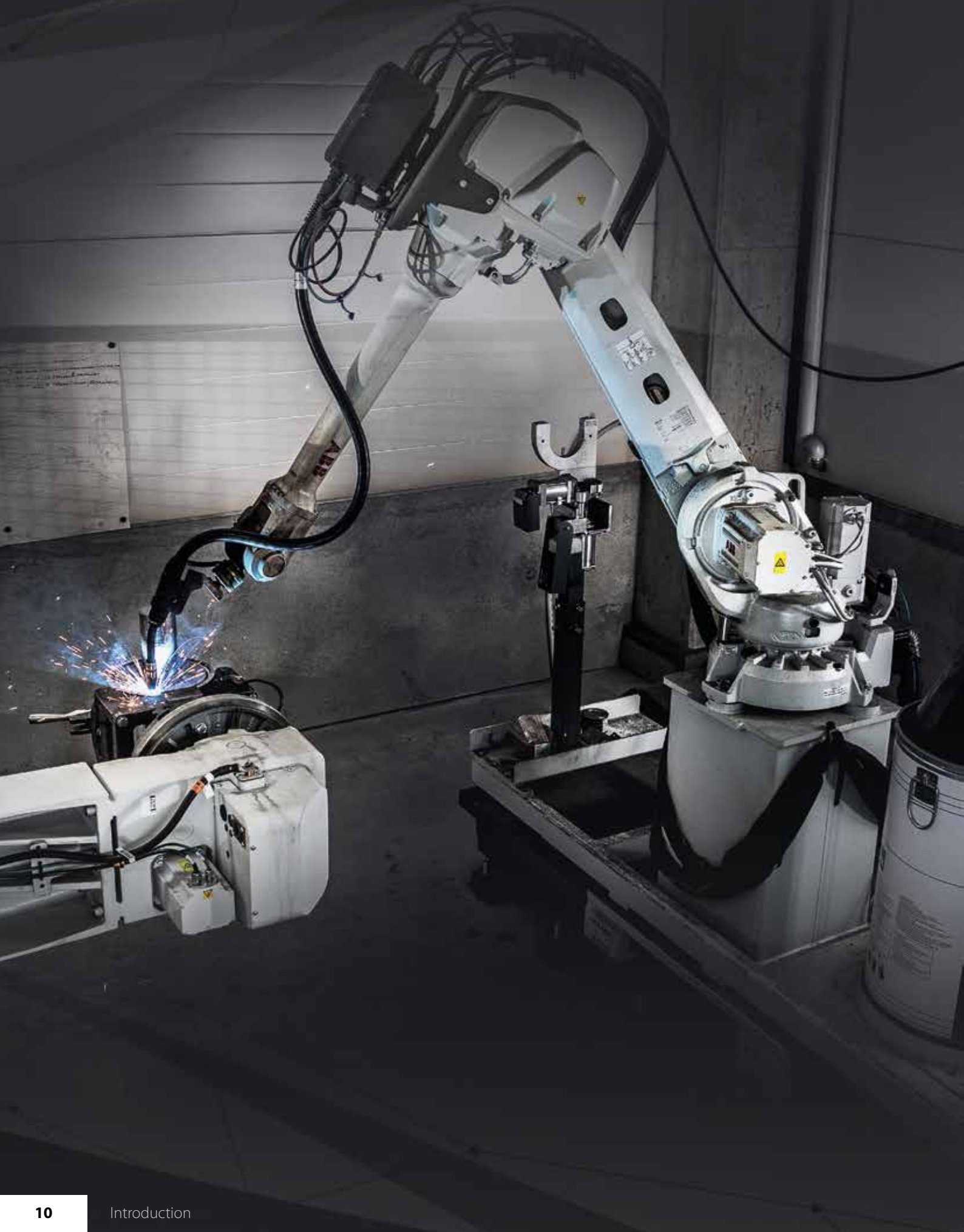



# Introduction

Kemppi develops and offers cutting edge solutions for robotic and automated arc welding applications.

Kemppi offers arc welding equipment for highly efficient and cost-effective robotic welding applications, ranging from thin sheet products to heavy plates and from mild and stainless steel to aluminum applications.

Our complete process packages consist of robust welding gun, reliable wire feeder, modern powers source, clever connection cable solutions and complete offering of process related accessories.

With Kemppi's unique Wise processes you reach new levels of productivity in robotic welding. There are application specific Wise solutions available to help you win a competitive edge over your competitors. Our intense research and development of the welding processes guarantees the best support for every Kemppi customer today and in the future, during the entire life cycle of the robotic arc welding system.

Kemppi solutions can be selected from different technology and cost levels and thus the final solution always provides best value for the investment – without compromising the quality.

Kemppi arc welding process packages are easy to install and work perfectly with all well-known robot brands. Solutions can utilize all common modern fieldbus protocols for communication between the robot controller and the power source. Also analogue interface is available for retrofit cases.



Also with CANOpen.



# Wise products

Achieve competitive edge with Kemppi application software. Solutions are designed to make the welding equipment perform optimally at any work.

For Automation Kemppi offers two advanced functions, WiseFusion and WisePenetration. With these functions you can perform better on everyday welding tasks. If you like to guarantee an excellent penetration and low heat input as well as speed up welding in any position, choose WiseFusion. For elimination of unwanted effects of stick-out length variations during welding choose WisePenetration.

Combined together these two functions are enabling use of Kemppi Reduced Gap Technology (RGT) which can reduce welding time and costs radically in thick plate welding applications.

In addition to Wise functions Kemppi offers two advanced Wise processes, WiseRoot and WiseThin. WiseRoot is designed for welding of root passes of pipes or plates with higher speed and high quality. WiseThin is developed for thin sheet applications where you get an easily controllable and stable arc as well as faster welding speed in any welding position.

Welding performance properties	WiseFusion	WisePenetration	WiseThin	WiseRoot	RGT
Efficient welding penetration	**	*			***
Reduced groove volume because of energy dense arc	**	*			***
Welding penetration stability regardless stick-out length	*	***			***
Higher travel speed with same throath thickness	***	*			***
Reduced heat input in plate thicknesses above 3 mm	***	*	*		**
Reduced heat input in plate thicknesses under 3 mm	*		***	**	
Less distortion in sheet metal welding	*		**	*	
High productivity root pass welding			*	***	

Suitable materials	WiseFusion	WisePenetration	WiseThin	WiseRoot	RGT
Unalloyed and low alloyed steels	●	●	●	●	●
High strength steels	●	—	●	●	○
Stainless steels	●	○	●	●	○
High alloyed steels	●	○	●	●	○
Aluminum	●	—	—	—	—
Copper/brazing	●	—	●	—	—

	WiseFusion	WisePenetration	WiseThin	WiseRoot	RGT
A7 MIG Welder	●	●	●	●	●
KempArc Pulse	●	●	●	●	
KempArc SYN			●	●	



# WISEFUSION



WiseFusion optimized welding function produces a very narrow and energy dense welding arc making welding faster and heat input lower. Focused penetration area allows the welding of narrow and deep grooves. WiseFusion results in excellent penetration without a risk of undercut. Narrower arc also facilitates weld pool control in position welding. WiseFusion ensures optimum arc length eliminating the need for constant parameter settings. Adaptive and automatic arc length regulation maintains the arc always within the short circuit boundaries and raises your arc-on time.

## BENEFITS

- Higher welding speed
- Lower heat input resulting in less distortion and better mechanical properties of the weld
- Possibility to weld narrower and deeper grooves
- Excellent weld pool control in position welding
- Easy to weld in all positions
- Automatic arc length control granting always the right parameters
- Easy to use
- Uniform weld quality

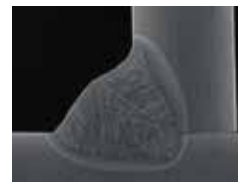

1-MIG

VS



1-MIG avec WiseFusion

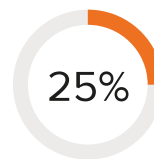

### MORE WELD WITH WISEFUSION

Gives better fusion of materials resulting in proper penetration, increased welding speed and less distortion on the workpiece. Improves productivity and quality.

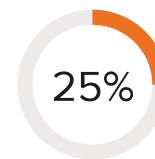

### LOWER HEAT INPUT

Than in traditional MIG/ MAG welding processes, delivering savings in rework costs.

	Ordering code	Description
A7 MIG Welder	A7500000	WiseFusion
KempArc Pulse	9991015	WiseFusion-A



# WISEPENETRATION



WisePenetration optimized welding function is designed to keep welding current and thus penetration invariable regardless of the changes in stick-out length in manual welding. Normally in MIG/MAG welding the power to the weld pool is changing as the welder or weld piece dictates the distance between the joint and welding gun nozzle. These deviations may result in quality issues such as lack of fusion, incomplete or inconsistent penetration, changes in weld profile and of course welding spatter. WisePenetration solves these issues and reduces the need for post-grinding and repair work. The function prevents the current from dropping down by actively adjusting wire feeding. This helps to keep the weld mechanical properties on a desired level and prevents welding defects. The user sets the wished current level, and with the help of WisePenetration, the current level does not drop below this level when stick-out length increases.

WisePenetration welding function is available for ferritic synergic MAG welding programs. WisePenetration is an optional software product for Kempfi FastMig M, and FastMig X welding equipment, but featured as standard in FastMig X Intelligent setup.

## BENEFITS

- Ensured penetration even in case of:
- Narrow structures where visibility of the arc is a problem
  - Limited visibility or accessibility
  - Position welding
  - Difficult-to-weld joints

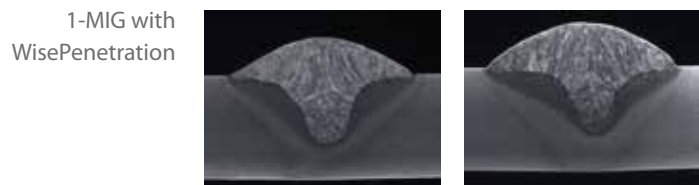
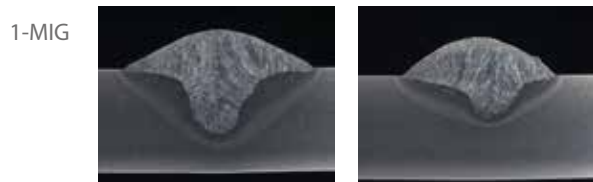
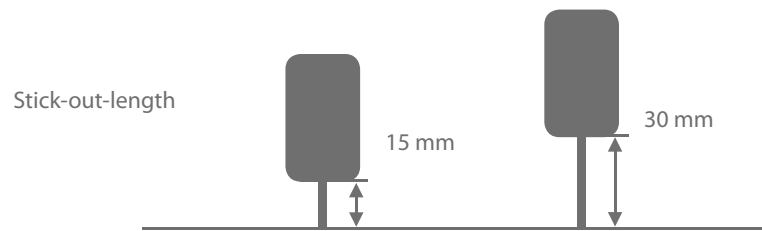

	Ordering code	Description
A7 MIG Welder	A7500001	WisePenetration
KempArc Pulse	9991010	WisePenetration-A



# WISETHIN



WiseThin is developed for faster and productive manual sheet welding, for ferrous and non ferrous materials. With the process you can weld in any position and also down hand, even with wide gap or varying gap tolerances. Weld pool control is excellent and the amount and size of spatters reduced. WiseThin provides even 25% lower heat input than normal MIG/MAG welding, reducing material distortion and post weld rework.

Process offers excellent welding characteristics in plate thicknesses 0.8 - 3.0 mm, even with CO<sub>2</sub> shielding gas. Welding speed is higher than in traditional short arc welding. Refinement of the process is based on accurate and real-time voltage measurement and filler wire droplet detachment. Thus droplet transfer to the weld pool is soft and controlled. WiseThin+ is a MIG/MAG welding process 131, 133, 135, 136 and 138 according to standard EN ISO 4063. WiseThin+ welding process is a further developed process mode for A7 mig welder.

## BENEFITS

- Higher welding speed than in traditional shot arc welding
- High quality welds, reduced post weld rework
- Lower heat input and thus also less deformation
- Decreased amount and size of spatters
- Stable arc for positional welding for thicker plate thicknesses
- Excellent arc ignition for tack and intermittent welds
- Savings in welding costs as you get mixed gas welding characteristics with pure CO<sub>2</sub>
- Down hand and all positional welding
- Easy to make short welds because of accurate arc control
- Suitable for brazing
- Expands the parameter window and thus reduces the need to use smaller wire diameters
- Soft and pleasant arc characteristics
- Easy to use



	Ordering code	Description
A7 MIG Welder	9990419	WiseThin+
KempArc Pulse	6265013	WiseThin-A
KempArc Synergic	6265013	WiseThin-A





# WISEROOT



WiseRoot is an optimized short arc process for root pass welding without backing. The process is highly effective being significantly faster than stick (MMA), TIG and standard MIG/MAG short arc welding, yet producing high quality welds. The welding of fixed pipes in any position is possible and groove angle can be reduced by even 40%, depending on the application.

A stable and efficient arc resulting in excellent weld quality is enabled through precise real time voltage measuring, current control and right in time filler metal droplet releasing. Filler metal transfer is smooth and spatter-free. WiseRoot is a MIG/MAG welding process 131, 133, 135, 136 or 138 according to standard EN ISO 4063. WiseRoot+ welding process is a further developed process mode for A7 mig welder.

## BENEFITS

- Increases welding speed compared to MMA, TIG and standard MAG short arc welding
- Gives the possibility to reduce groove volume
- Allows wide range of root gaps and faces without incomplete or excessive penetration
- Easier to learn welding technique
- No need for backing ring
- Less spatter
- Allows welding of fixed pipes in all positions
- Allows welding of rotated pipes
- Allows welding with long cables
- Processes can be used with different materials; steel, stainless steels and high alloyed steels
- In WiseRoot+ excellent arc characteristic also with CO<sub>2</sub>
- Wide selection of wire diameter (0.8 – 1.2)

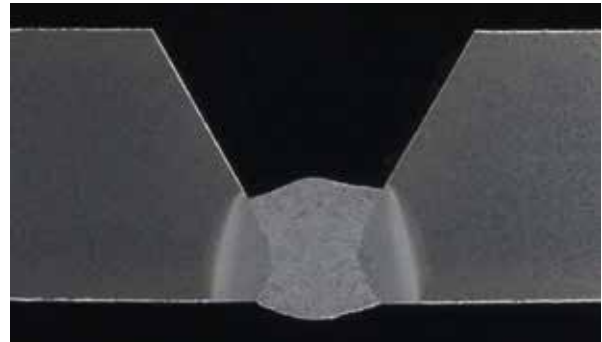

	Ordering code	Description
A7 MIG Welder	9990418	WiseRoot+
KempArc Pulse	9991011	WiseRoot-A
KempArc Synergic	9991011	WiseRoot-A



# KEMPPI REDUCED GAP TECHNOLOGY (RGT) SOLUTION



In A7 MIG Welder both WiseFusion and WisePenetration can be activated simultaneously thus enabling new benefits in form of RGT solution.

Reducing the groove angle can add significantly to the efficiency and productivity of welding of heavy metal structures. Kemppi has developed a new solution, Reduced Gap Technology (RGT). This technology allows reliable and efficient narrow gap welding with no need for special equipment or accessories for material thicknesses of up to 30 mm. The RGT combines intelligent arc control with Kemppi's high-tech power source, wire feeder and mechanization equipment.

## EXAMPLE BENEFITS

- 20° Groove angle instead of 45° – 60°
- 38% savings in arc time
- 25% savings in filler material
- 5 weld passes needed instead of 7



	Ordering code	Description
A7 MIG Welder	A7500000	WiseFusion
A7 MIG Welder	A7500001	WisePenetration





- 1 Power source
- 2 Wire feeder
- 3 Wire feeder roller kit
- 4 Water cooling unit
- 5 Robot interface module
- 6 Interconnection cables
- 7 Interconnection cable brackets
- 8 Earth return cable
- 9 Wire conduit
- 10 Wire spool holder
- 11 Wire spool protective cover
- 12 Floor stand for wire spool holder
- 13 Wire feeder attachment bracket
- 14 Wise processes
- 15 Welding gun package
- 16 Welding gun cleaning station



# A7 MIG Welder

## Engineered for your profit

A7 MIG Welder is the state-of-the-art solution for robotic arc welding, ideal for integration with any robot brand. It is a complete, perfectly balanced process package that includes a welding gun, wire feeder, power source, and cooling unit. The equipment is designed to meet the highest Kempfi standards, which guarantee reliable welding performance with no compromises. The Kempfi Wise software provides added value for customers by significantly improving welding speed, boosting production efficiency, and enabling the same equipment to be used for a variety of welding tasks. The system's modern, browser-based user interface allows easy access to the power source from a standard computer with a regular browser. This enables unprecedented savings in setup time and provides quality control benefits throughout the equipment's life cycle.

### BENEFITS

- Quick and easy integration with any robot brand with modern fieldbus hardware modules.
- Access to the power source from an external computer via ethernet with a regular web browser. No extra programs needed. Enables radical savings in setup time, as well as quick and easy parameter configuration, system management, and monitoring throughout the equipment's life cycle.
- Increased productivity and a short payback period thanks to the Wise software and a wide range of available functions. Wise processes are fine-tuned and pre-set to optimize productivity with welding speeds typically used in automated welding. The same equipment can be used for a wide variety of welding tasks and applications.
- A comprehensive, completely balanced package from one supplier results in significant savings in time and effort when integrating the arc-welding package with the robot application.
- Suitable for any industry using robotic welding for thin and thick mild steel, stainless steel, and aluminum components.
- Enhanced arc ignition functionality (Touch Sense Ignition) delivers minimum spatter and stabilizes the arc immediately after ignition.
- The robust wire feeding casing with integrated wire feeder controller electronics enables faster and more accurate control with better resistance to external interference.
- An integrated gas-flow sensor in the wire feeder enables the shielding gas flow to be monitored closer to the arc by default – no need for additional sensors.
- Search voltage level for the system can be set up freely from web browser interface





## ① A7 POWER SOURCE 350 / 450



A7 MIG Welder 350 and 450 are welding power sources designed for demanding professional use in robotic welding systems. They are suitable for synergic pulsed MIG/MAG, synergic 1-MIG and basic MIG/MAG welding, as well as the modified WiseRoot+™ and WiseThin+™ processes. The robot interface unit on top of the power source handles the communication with a robot and contains all necessary connections to integrate with a welding cell. The unit has an internal web server for easy control of welding and setup parameters via any device equipped with an internet browser including robot teach pendants.

### TECHNICAL SPECIFICATIONS

	A7 Power Source 350	A7 Power Source 450
Ordering code	6201350	6201450
Connection voltage 1~ 50/60 Hz	N/A	N/A
Connection voltage 3~ 50/60 Hz	400 V, -15 %...+20 %	400 V, -15 %...+20 %
Fuse (delayed)	25 A	35 A
Minimum generator power	35 kVA	35 kVA
Welding range	20 A / 12 V - 350 A / 46 V	20 A / 12 V - 450 A / 46 V
Output 60% ED	350 A	450 A
Output 100% ED	330 A	350 A
Mains connection cable	4G6 (5 m)	4G6 (5 m)
Supply current (maximum)	23 A	32 A
Supply current (effective)	21 A	25 A
Idle power	25 W	25 W
Power factor at max. current	0.85	0.88
No-load voltage (peak)	U <sub>0</sub> = 80 V - 98 V	U <sub>0</sub> = 80 V - 98 V
Open circuit voltage (average)	85 V - 103 V	85 V - 103 V
Efficiency (100 % duty cycle)	87 %	87 %
Minimum short circuit power S <sub>sc</sub> of supply network	5.5 MVA	5.5 MVA
Max apparent power	22 kVA	22 kVA
Power supply for cooling unit	24 V DC / 50 VA	24 V DC / 50 VA
Power supply for auxiliary unit	50 V DC / 100 W	50 V DC / 100 W
Operating temperature range	-20 ... +40 °C	-20 ... +40 °C

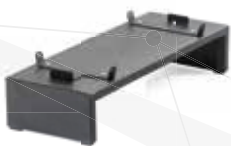

### STAND FOR POWER SOURCE

Ordering code 6185295

For easy transport and keeping floor free under welder



## ② A7 WIRE FEEDER 25



The A7 Wire Feeder 25 is a durable and powerful two motor for 4-wheel feeding system designed to work seamlessly with A7 MIG Welder power sources. A separate attachment bracket is required for mounting the wire feeder on robot.

Integrated functionalities:

- Gas test button
- Wire feed and wire retract buttons
- Integrated gas flow sensor
- Min. flow rate monitoring
- Compressed air blow valve to gun cleaning
- Euro/Power pin -connector versions available
- Back light provided behind drive wheels
- Support for push/pull torches

### TECHNICAL SPECIFICATIONS

	A7 Wire Feeder 25-LH-EUR	A7 Wire Feeder 25-LH-PP
Ordering code	6203510	6203502
Wire feed mechanism	4-roll, two motors	4-roll, two motors
Wire feed speed adjustment	0.5 – 25 m/min	0.5 – 25 m/min
Gun connection	Euro	PP
Filler wire sizes (Fe solid)	0.8 – 1.6 mm	0.8 – 1.6 mm
Filler wire sizes (Fe cored)	1.0 – 1.6 mm	1.0 – 1.6 mm
Filler wire sizes (Ss)	0.8 – 1.6 mm	0.8 – 1.6 mm
Filler wire sizes (Al)	1.0 – 2.4 mm	1.0 – 2.4 mm
Filler wire sizes (CuSi)	0.8 – 1.2 mm	0.8 – 1.2 mm
Operating voltage (safety voltage)	50 V DC	50 V DC
Operating temperature range	-20 ... +40 °C	-20 ... +40 °C
External dimensions LxWxH	380 × 250 × 170 mm	380 × 250 × 170 mm
Weight (no accessories)	7.8 kg	7.8 kg
Degree of protection	IP21S	IP21S
EMC class	A	A
Storage temperature range	-40 ... +60 °C	-40 ... +60 °C

### RH-MODELS (RIGHT HAND)

Ordering code	6203501	A7 Wire Feeder 25-RH-EUR	Brackets only for non-hollow wrist robots
Ordering code	6203503	A7 Wire Feeder 25-RH-PP	Brackets only for non-hollow wrist robots



### 3 WIRE FEED ROLL KITS



FE = Mild Steel  
 SS = Stainless Steel  
 AL = Aluminium  
 U = U Groove  
 V = Plain V Groove  
 VK = Knurled V Groove  
 T = Trapezoid Groove  
 HD = Heavy Duty kit (contains metal feed rolls)  
 MC/FC = Metal/Flux Cored  
 Front guide tube length for kits is optimized as follows:

“GT04 T #3” = A7 MIG WIRE FEEDER A 25 – EUR  
 Kemppi robotic welding guns  
 Binzel robotic welding guns

“GT04 T #4” = A7 MIG WIRE FEEDER A 25 – EUR  
 Dinse robotic welding guns

“GT04 T #5” = A7 MIG WIRE FEEDER A 25 - PP  
 Binzel robotic welding guns

“GT04 T #6” = A7 MIG WIRE FEEDER A 25 - PP  
 Dinse robotic welding guns

Ordering code	Description
F000367	FE (MC/FC) V0.8-0.9 GT04 T KIT #3
F000368	FE (MC/FC) V1.0 GT04 T KIT #3
F000369	FE (MC/FC) V1.2 GT04 T KIT #3
F000370	FE (MC/FC) V1.4 GT04 T KIT #3
F000371	FE (MC/FC) V1.6 GT04 T KIT #3
F000372	FE (MC/FC) V0.8-0.9 HD GT04 T KIT #3
F000373	FE (MC/FC) V1.0 HD GT04 T KIT #3
F000374	FE (MC/FC) V1.2 HD GT04 T KIT #3
F000375	FE (MC/FC) V1.6 HD GT04 T KIT #3
F000376	SS,CU (FE) V0.8-0.9 GT04 T KIT #3
F000377	SS,CU (FE) V1.0 GT04 T KIT #3
F000378	SS,CU (FE) V1.2 GT04 T KIT #3
F000379	SS,CU (FE) V1.4 GT04 T KIT #3
F000380	SS,CU (FE) V1.6 GT04 T KIT #3
F000381	SS,CU (FE) V2.0 GT04 T KIT #3
F000382	SS,CU (FE) V2.4 GT04 T KIT #3
F000383	SS (FE) V0.8-0.9 HD GT04 T KIT #3
F000384	SS (FE) V1.0 HD GT04 T KIT #3
F000385	SS (FE) V1.2 HD GT04 T KIT #3
F000386	SS (FE) V1.6 HD GT04 T KIT #3
F000387	MC/FC VK1.0 GT04 T KIT #3
F000388	MC/FC VK1.2 GT04 T KIT #3
F000389	MC/FC VK1.4-1.6 GT04 T KIT #3
F000390	MC/FC VK1.0 HD GT04 T KIT #3
F000391	MC/FC VK1.2 HD GT04 T KIT #3
F000392	MC/FC VK1.4-1.6 HD GT04 T KIT #3
F000393	AL U1.0 GT04 T KIT #3

Ordering code	Description
F000394	AL U1.2 GT04 T KIT #3
F000395	AL U1.4 GT04 T KIT #3
F000396	AL U1.6 GT04 T KIT #3
F000397	SS,CU (FE) V0.8-0.9 GT04 T KIT #4
F000398	SS,CU (FE) V1.0 GT04 T KIT #4
F000399	SS,CU (FE) V1.2 GT04 T KIT #4
F000400	SS (FE) V0.8-0.9 HD GT04 T KIT #4
F000401	SS (FE) V1.0 HD GT04 T KIT #4
F000402	SS (FE) V1.2 HD GT04 T KIT #4
F000403	AL U1.0 GT04 T KIT #4
F000404	AL U1.2 GT04 T KIT #4
F000405	SS,CU (FE) V0.8-0.9 GT04 T KIT #5
F000406	SS,CU (FE) V1.0 GT04 T KIT #5
F000407	SS,CU (FE) V1.2 GT04 T KIT #5
F000408	SS (FE) V0.8-0.9 HD GT04 T KIT #5
F000409	SS (FE) V1.0 HD GT04 T KIT #5
F000410	SS (FE) V1.2 HD GT04 T KIT #5
F000411	AL U1.0 GT04 T KIT #5
F000412	AL U1.2 GT04 T KIT #5
F000413	SS,CU (FE) V0.8-0.9 GT04 T KIT #6
F000414	SS,CU (FE) V1.0 GT04 T KIT #6
F000415	SS,CU (FE) V1.2 GT04 T KIT #6
F000416	SS (FE) V0.8-0.9 HD GT04 T KIT #6
F000417	SS (FE) V1.0 HD GT04 T KIT #6
F000418	SS (FE) V1.2 HD GT04 T KIT #6
F000419	AL U1.0 GT04 T KIT #6
F000420	AL U1.2 GT04 T KIT #6





## 4 WATER COOLING UNIT



These Cooling units are designed to be used with A7 MIG Welder for cooling the welding gun. The operation of these units is microprocessor-controlled.

### TECHNICAL SPECIFICATIONS

	A7 Cooler
Ordering code	6068220
Operating voltage (safety voltage)	400 V -15 ...+20 %
Maximum pressure	0.4 Mpa
External dimensions LxWxH	570 x 230 x 280 mm
Weight (no accessories)	11 kg
Degree of protection	IP23S
Tank volume	~3 L
EMC class	A
Cooling power	1 kW
Storage temperature range	-40 ...+60 °C
Operating temperature	-20 ...+40 °C
Flow sensor type	[l/min]

### COOLING LIQUID

Ordering code	SP9810765	10 liter can
---------------	-----------	--------------



## 5 ROBOT INTERFACE MODULE



Fieldbus communication between power source and robot controller is enabled with modules. The protocol can be chosen based on customer preference.

Ordering code	Description
9774121DEV	ANYBUS-CC M30 DEVICENET
9774121DEV12	ANYBUS-CC M30 DEVICENET M12
9774121ETC	ANYBUS-CC M30 ETHERCAT
9774121ETH2	ANYBUS-CC M30 ETHERNET/IP 2-PORT
9774121MBR	ANYBUS-CC M30 MODBUS-RTU
9774121MBT	ANYBUS-CC M30 MODBUS-TCP
9774121MBT2	ANYBUS-CC M30 MODBUS-TCP 2-PORT
9774121PRF	ANYBUS-CC M30 PROFIBUS
9774121PRN	ANYBUS-CC M30 PROFINET IO
9774121PRN2	ANYBUS-CC M30 PROFINET IO 2-PORT

## 6 INTERCONNECTION CABLES



The interconnection cable set contains several cables and hoses. The cable set is used for delivering the welding power, shielding gas, cooling liquid, and control signals from the welding power source to the wire feeder. Interconnection cable sets are available in zipper bags or in corrugated sleeves.

Ordering code	Description
6185485	A7 CONTROL CABLE 5m
6185486	A7 CONTROL CABLE EXTENSION 5m
61854851	A7 CONTROL CABLE 10m
61854861	A7 CONTROL CABLE EXTENSION 10m
61854852	A7 CONTROL CABLE 15m
61854853	A7 CONTROL CABLE 20m
SP007110	VOLTAGE SENSING CABLE
SP800887	A7 SIGNAL CABLE KIT 30m



## GAS COOLED CABLE SETS

Ordering code	Description	Additional info
6260458	ROBOT 70-5-GH CABLE SHOE	Zipper bag, 70 mm <sup>2</sup> , 5 m , screw connection to wire feeder (non dix), dix connector to powersource, gas cooled
6260449	ROBOT 70-10-GH CABLE SHOE	Zipper bag, 70 mm <sup>2</sup> , 10 m , screw connection to wire feeder (non dix), dix connector to powersource, gas cooled
6260484	ROBOT 70-15-GH CABLE SHOE	Zipper bag, 70 mm <sup>2</sup> , 15 m , screw connection to wire feeder (non dix), dix connector to powersource, gas cooled
6260480	ROBOT 70-20-GH CABLE SHOE	Zipper bag, 70 mm <sup>2</sup> , 20 m , screw connection to wire feeder (non dix), dix connector to powersource, gas cooled
6260483	A7 ROBOT 70-5-GH	Corrugated sleeve, 70 mm <sup>2</sup> , 5 m, cable shoe, gas cooled
6260486	A7 ROBOT 95-20-GH CABLE SHOE	Zipper bag, 95 mm <sup>2</sup> , 20 m , screw connection to wire feeder (non dix), dix connector to powersource, gas cooled

## WATER COOLED CABLE SETS

Ordering code	Description	Additional info
6260459	ROBOT 70-5-WH CABLE SHOE	Zipper bag, 70 mm <sup>2</sup> , 5 m , screw connection to wire feeder (non dix), dix connector to powersource, water cooled
6260460	ROBOT 70-10-WH CABLE SHOE	Zipper bag, 70 mm <sup>2</sup> , 10 m , screw connection to wire feeder (non dix), dix connector to powersource, water cooled
6260481C1	ROBOT 70-15-WH CABLE SHOE	Zipper bag, 70 mm <sup>2</sup> , 15 m , screw connection to wire feeder (non dix), dix connector to powersource, water cooled
6260481	ROBOT 70-20-WH CABLE SHOE	Zipper bag, 70 mm <sup>2</sup> , 20 m , screw connection to wire feeder (non dix), dix connector to powersource, water cooled
6260482	A7 ROBOT 70-5-WH	Corrugated sleeve, 70 mm <sup>2</sup> , 5 m, cable shoe, water cooled
62620487	A7 ROBOT 95-20-WH CABLE SHOE	Zipper bag, 95 mm <sup>2</sup> , 20 m , screw connection to wire feeder (non dix), dix connector to powersource, gas cooled

## 7 INTERCONNECTION CABLE BRACKETS



Ordering code	Additional info
SP800888	Works together with interconnection cables with corrugated sleeve. Kit includes an adapter plate for KUKA KR CYBERTECH series robots for 2nd joint attachment.
9370131	Works together with interconnection cables with corrugated sleeve. For each clamp (9370131) also 2x jaws are required (9370133)



Ordering code	SP008072	Metal attachment piece, two cable ties, for zipper bag
---------------	----------	--



## 8 EARTH RETURN CABLE



Ordering code	Description	Additional info
6184711	EARTH RETURN CABLE 70 mm <sup>2</sup> 5m	Dix connector for the power source, 5 m, 70 mm <sup>2</sup>
6184712	EARTH RETURN CABLE 70 mm <sup>2</sup> 10m	Dix connector for the power source, 10 m, 70 mm <sup>2</sup>
6184713	EARTH RETURN CABLE 70 mm <sup>2</sup> 15m	Dix connector for the power source, 15 m, 70 mm <sup>2</sup>

## 9 WIRE CONDUIT FOR WIRE SPOOLS

High quality wire conduit delivers the filler wire smoothly from wire spool to wire feeder. Male connectors on both ends fit to Kemppi feeder and Kemppi wire spool support. Order codes does not include female snap connector for wire spool holder or wire drum. It must be ordered separately. In case of stainless steel or aluminium, a separate chili liner is also required.

### WIRE CONDUITS (STANDARD LENGTH)



Ordering code	Description
SP600535	WIRE CONDUIT-1.8M ROBOT KEMPPi
SP600536	WIRE CONDUIT-3.0M ROBOT KEMPPi
SP800803	WIRE CONDUIT-4.0M ROBOT KEMPPi
SP600537	WIRE CONDUIT-5.0M ROBOT KEMPPi
SP600686	WIRE CONDUIT-8.0M ROBOT KEMPPi
SP600731	ADDITIONAL CHILI LINER KIT FOR STAINLESS STEEL AND ALUMINUM WELDING CASES



## 9 WIRE CONDUIT FOR WIRE DRUMS

Alternative solution for wire conduit when distance between wire feeder and wire drum is greater than 5 meters. NOTE: When ordering W005195 with the desired length, you also need snap connectors: two male (W005197) and one female (W005189).

### 9.1 WIRE CONDUITS (CUSTOM LENGTH)



Ordering code W005195

Custom length for your delivery (max. 27 m)

### 9.2 SNAP CONNECTOR FOR WIRE CONDUIT (MALE)



Ordering code W005197

Male connector for wire conduit, two pieces needed per conduit

### 9.3 SNAP CONNECTOR FOR DRUM OR SPOOL HOLDER (FEMALE)



Ordering code W005189

Female connector for the wire drum or spool holder



## 10 WIRE SPOOL HOLDER



Suitable for standard 15 kg wire coil. NOTE: Female connector for wire conduit not included. Must be ordered separately.

Ordering code	Description	Additional info
W007628	WIRE SPOOL SUPPORT RIGHT	wire spool holder
W007629	WIRE SPOOL SUPPORT LEFT	wire spool holder

## 11 PROTECTIVE COVER FOR WIRE SPOOL



Ordering code	SP007940	Plastic cover for wire spool holder
---------------	----------	-------------------------------------

## 12 FLOOR STAND FOR WIRE SPOOL HOLDER



Ordering code	W007356	Floor stand for wire spool holder
---------------	---------	-----------------------------------



## 13 WIRE FEEDER MOUNTING BRACKETS



Brackets for mounting the wire feeder on the robot's 3rd axis. The design is robot model specific. Order code includes metal plates, insulation rings and screws. Screws for robot's 3rd axis are not included.

ABB	IRB 1520ID	SP800710
ABB	IRB 1600ID	SP800714
ABB	IRB 1660ID	SP800714
ABB	IRB 2400/10	SP800713
ABB	IRB 2400/16	SP800713
ABB	IRB 2600ID-15/1,85	SP800712
ABB	IRB 2600ID-8/2.00	SP800712
Fanuc	100iC-7L	SP800716
Fanuc	100iC-8L	SP800716
Fanuc	100iC-12	SP800716
Fanuc	100iC-12S	SP800716
Fanuc	120iC	SP800716
Fanuc	120iC-12L	SP800716
Fanuc	100iD	SP800981
Fanuc	100iD-10L	SP800981
Fanuc	M-710iC/12L	SP801089
Kawasaki	BA006N	SP800717
Kawasaki	BA006L	SP800717
Kawasaki	RA010L	SP800776
Kawasaki	RA006L	SP800776
Kawasaki	RA010N	SP800776
Kawasaki	RA020N	SP800776
KUKA	KR 5 ARC HW	SP800708
KUKA	KR 5-2 ARC HW	SP800708
KUKA	KR6 R1820 ARC HW	SP800755
KUKA	KR8 R1420 ARC HW	SP800755
KUKA	KR8 R1620 ARC HW	SP800755
KUKA	KR8 R2100 ARC HW	SP800900
KUKA	KR16 Arc HW	SP800709

KUKA	KR16 L8 Arc HW	SP800709
KUKA	KR5 Arc	SP800707
KUKA	KR6-2	SP800810
KUKA	KR6 R1820	SP800707
KUKA	KR8 R1620	SP800810
KUKA	KR8 R2010	SP800810
KUKA	KR10 R1420	SP800810
MOTOMAN	GP12	SP800718
MOTOMAN	GP25	SP800718
MOTOMAN	GP25 - 12	SP800775
MOTOMAN	MA1440	SP800718
MOTOMAN	MA2010	SP800775
MOTOMAN	MA1440 AWK-CWK	SP800858
MOTOMAN	MA2010 AWK-CWK	SP800985
MOTOMAN	MH50	SP800988
MOTOMAN	MH50-35II	SP800988
MOTOMAN	MH50-20IIz	SP800988
MOTOMAN	MA1400	SP800720
MOTOMAN	VA1400	SP800720
MOTOMAN	MA1550	SP800720
MOTOMAN	MA1800	SP800719
MOTOMAN	MA1900	SP800719
MOTOMAN	EA1400N	SP800719
MOTOMAN	EA1900N	SP800719
MOTOMAN	UP6	SP800997
MOTOMAN	EA1900	SP800916
MOTOMAN	MH6/MH6S/HP20D/HP20D-6	SP800996



## 14 WISE PROCESSES



Ordering code	Description
A7500000	WiseFusion
A7500001	WisePenetration
9990419	WiseThin+
9990418	WiseRoot+

## 15 WELDING GUN PACKAGE



See robotic gun packages page 62

## 16 WELDING GUN CLEANING STATION



See robotic gun packages page 86 more information.

Ordering code	SP600674	Robot gun cleaning station
---------------	----------	----------------------------





## OPTIONAL ITEMS

### 17 MOUNTING KIT A7 DUAL FEEDER



For non-hollow wrist robot models and applications where welding gun exchange unit is used this set enables use of two wire feeders and one power source combination. Switching between two wire feeders can be done from robot controller. The kit includes a wire feeder switching card, a flat band cable, and a harness with connectors for the wire feeder and for the mother board of the robot interface unit.

Ordering code SP013699

Enables switching between two A7 wire feeders with one A7 power source



- |   |                                |    |                                   |
|---|--------------------------------|----|-----------------------------------|
| 1 | Power source                   | 9  | Wire conduit                      |
| 2 | Wire feeder                    | 10 | Wire spool holder                 |
| 3 | Wire feeder roller kit         | 11 | Wire spool protective cover       |
| 4 | Water cooling unit             | 12 | Floor stand for wire spool holder |
| 5 | Robot interface module         | 13 | Wire feeder mounting bracket      |
| 6 | Interconnection cables         | 14 | Wise processes                    |
| 7 | Interconnection cable brackets | 15 | Welding gun package               |
| 8 | Earth return cable             | 16 | Welding gun cleaning station      |



# KempArc Pulse

## Automated quality and productivity

KempArc Pulse is a modular pulsed MIG/MAG welding automation system that offers productivity, flexibility, and much more. By combining the reliable and consistent weld quality of robotic welding with the excellent arc characteristics and fast communication of KempArc Pulse, you are able to boost your production to a whole new level. In addition, you are able to unlock the full potential of Kemppi Wise welding processes for automated welding. They offer additional productivity boost in thin sheet as well as in heavy duty applications. KempArc Pulse is available both in analogue and digital models for integration with different robotic control systems.

### BENEFITS

- Robot interface integrated in the power source
- Compatible with Kemppi Wise welding functions and processes
- Fast fieldbus-based communication guarantees integration with all common robot brands
- Available in digital and analogue models for varied integration possibilities
- Compact and lightweight wire drive mechanism
- Remote control options bring flexibility



copyright© KUKA AG



## ① KEMPARC PULSE 350 / 450 POWER SOURCE



KempArc Pulse 350, 450 are CC/CV power sources, designed for demanding professional use. They are suitable for synergic MIG/MAG, synergic 1-MIG and basic MIG/MAG. There is analog model available from KempArc Pulse 450 (AN). For digital models select interface card separately.

### TECHNICAL SPECIFICATIONS

	KEMPARC PULSE 350 POWER SOURCE	KEMPARC PULSE 450 POWER SOURCE
Ordering code	6200350	6200450 / 6200450AN
Connection voltage 3~ 50/60 Hz	400 V -15...+20%	400 V -15...+20%
Fuse (delayed)	25 A	35 A
Minimum generator power	35 kVA	35 kVA
Welding range	10 ... 50 V	10 ... 50 V
Open circuit voltage	50 V	50 V
Rated power 80% ED	16.0 kVA	221.1 kVA
Rated power 100% ED	15.3 kVA	17.8 kVA
Idle power (no load power)	100 W	100 W
Efficiency	88 %	88 %
Power factor	0.85	0.90
Voltage supply for auxiliary devices	50 V / 100 W	50 V / 100 W
Auxiliary device supply fuse (X14, X15)	6.3 A delayed	6.3 A delayed
Voltage supply for the cooling device	24 VDC / 50 W	24 VDC / 50 W
Max. output current	350 A (80 %)	450 A (60 %)
Operating temperature range	-20 ... +40 °C	-20 ... +40 ÅãC
External dimensions LxWxH	590 x 230 x 430 mm	590 x 230 x 430 mm
Weight (no accessories)	36 kg	37 kg
Degree of protection	IP23S	IP23S
EMC class	A	A
Storage temperature range	-40 ... +60 °C	-40 ... +60 °C
Operating temperature range	-20 ... +40 °C	-20 ... +40 °C

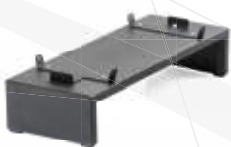

### STAND FOR POWER SOURCE

Ordering code 6185295

For easy transport and keeping floor free under welder



## ② KEMPARC DT400 / DT400L / DT410L WIRE FEEDER



Wire feeder for automated welding with a reliable 4-roll wire feed mechanism and full metal feed rolls. DT400 can be mounted on the back of the robot arm or integrated with any mechanized welding system. A separate attachment bracket is required for mounting the wire feeder on robot. Wire feeder with Euro connector is available in right and left hand models (L) and PowerPin version is available in left hand version.

### TECHNICAL SPECIFICATIONS

	KEMPARC DT400 WIRE FEEDER	KEMPARC DT 410 L WIRE FEEDER
Ordering code	6203400 / 6203400L	6203410
Operating voltage	50 VDC	50 VDC
Rated power	100 W	100 W
Loadability	40°C 100%ED 500 A	40°C 100%ED 500 A
Wire feed speed	0...25 m/min	0...25 m/min
Filler wires	0.8...1.6 mm	0.8...1.6 mm
Welding gun connector	Euro	PowerPin
Operating temperature range	-20...+40°C	-20...+40°C
EMC	class A	class A
Degree of protection	n IP23S	n IP23S
External dimensions	269 x 175 x 169 mm	269 x 175 x 169 mm
Weight	4.5 kg	4.5 kg



### 3 FEED ROLL KITS FOR DT400 WIRE FEEDER



U = U Groove  
V = Plain V Groove  
VK = Knurled V Groove  
T = Trapezoid Groove  
HD = Heavy Duty kit (contains metal feed rolls)  
MC/FC = Metal/Flux Cored

Ordering code	Description
F000350	FE (MC/FC) V0.8-0.9 HD DURATORQUE KIT #3
F000351	FE (MC/FC) V1.0 HD DURATORQUE KIT #3
F000352	FE (MC/FC) V1.2 HD DURATORQUE KIT #3
F000353	FE (MC/FC) V1.6 HD DURATORQUE KIT #3
F000354	SS (FE) V0.8-0.9 HD DURATORQUE KIT #3
F000355	SS (FE) V1.0 HD DURATORQUE KIT #3
F000356	SS (FE) V1.2 HD DURATORQUE KIT #3
F000357	SS (FE) V1.6 HD DURATORQUE KIT #3
F000358	MC/FC VK1.0 HD DURATORQUE KIT #3
F000359	MC/FC VK1.2 HD DURATORQUE KIT #3
F000360	MC/FC VK1.4-1.6 HD DURATORQUE KIT #3
F000361	MC/FC VK2.0 HD DURATORQUE KIT #3
F000362	AL U1.0 HD DURATORQUE KIT #3
F000363	AL U1.2 HD DURATORQUE KIT #3
F000364	AL U1.6 HD DURATORQUE KIT #3



## 4 KEMPCOOL 10 COOLING UNIT



Cooling unit suitable for use with Kemppi KempArc welding equipment. KempCool 10 performs 1 kW of cooling power with a three liter tank that can be filled with 20%-40% ethanol/water mixture, or any other suitable antifreeze agent.

### TECHNICAL SPECIFICATIONS

Ordering code	6208100
Connection voltage 3~ 50/60 Hz	400 V -15...+20%
Rated power	250 W (100 %)
Rated power 100% ED	250 W
Cooling liquid	20 - 40% Monopropylenglycol - water
Max. pressure at output	0.4 MPa
Operating temperature range	-20 ... +40 °C
External dimensions LxWxH	570 × 230 × 280 mm
Weight (no accessories)	11 kg
Degree of protection	IP23S
EMC class	A
Cooler tank volume	3 l
Cooling power	1 kW
Storage temperature range	-40 ... +60 °C

### COOLING LIQUID

Ordering code	SP9810765	10 liter can
---------------	-----------	--------------



## 5 ROBOT INTERFACE CARDS

Fieldbus communication between power source and robot controller is enabled with modules. The protocol can be chosen based on customer preference. Modules are placed inside the KempArc robot interface chassis.



Ordering code	Description
9774120CAN	INTERFACE CARD CAN OPEN
9774120DEV	FIELD BUS ADAPTER DEVICENET
9774120ETC	FIELD BUS INTERFACE ETHERCAT
9774120ETH	FIELD BUS ADAPTER ETHERNET
9774120IBC	FIELD BUS ADAPTER INTERBUS COPPER
9774120IBO	FIELD BUS ADAPTER INTERBUS OPTICAL
9774120PRF	FIELD BUS ADAPTER PROFIBUS
9774120PRN	FIELD BUS ADAPTER PROFINET

## 6 INTERCONNECTION CABLES



The interconnection cable set contains several cables and hoses. The cable set is used for delivering the welding power, shielding gas, cooling liquid, and control signals from the welding power source to the wire feeder. Interconnection cable sets are available in zipper bags or in corrugated sleeves.







## GAS COOLED CABLE SETS

Ordering code	Description	Additional info
6260441	ROBOT 70-5-GH	Corrugated sleeve, 70 mm <sup>2</sup> , 5m, Dix connector on both ends, Gas cooled
6260445	ROBOT 70-10-GH	Corrugated sleeve, 70 mm <sup>2</sup> , 10m, Dix connector on both ends, Gas cooled
6260446	ROBOT 70-5-GH DIX	Zipper bag, 70 mm <sup>2</sup> , 5 m, dix connector on both ends, Gas cooled
6260447	ROBOT 70-10-GH DIX	Zipper bag, 70 mm <sup>2</sup> , 10 m, dix connector on both ends, Gas cooled
6260442	ROBOT 70-5-GH CABLE SHOE	Suitable for DT 410 feeder, PowerPin connector for welding gun, cable shoe for feeder connection and dix for power source, 5 m, Gas cooled
6260443	ROBOT 70-10-GH CABLE SHOE	Suitable for DT 410 feeder, PowerPin connector for welding gun, cable shoe for feeder connection and dix for power source, 10 m, Gas cooled

## WATER COOLED CABLE SETS

Ordering code	Description	Additional info
6260461	ROBOT 95-5-WH	Corrugated sleeve, 95 mm <sup>2</sup> , 5m, Dix connector on both ends, Water cooled
6260465	ROBOT 95-10-WH	Corrugated sleeve, 95 mm <sup>2</sup> , 10m, Dix connector on both ends, Water cooled
6260465C2	ROBOT 95-30-WH	Corrugated sleeve, 95 mm <sup>2</sup> , 30m, Dix connector on both ends, Water cooled
6260465C3	ROBOT 95-20-WH	Corrugated sleeve, 95 mm <sup>2</sup> , 20m, Dix connector on both ends, Water cooled
6260465C4	ROBOT 95-15-WH	Corrugated sleeve, 95 mm <sup>2</sup> , 15m, Dix connector on both ends, Water cooled
6260478	ROBOT 70-5-WH DIX	Zipper bag, 70 mm <sup>2</sup> , 5 m, dix connector on both ends, Water cooled
6260479	ROBOT 70-10-WH DIX	Zipper bag, 70 mm <sup>2</sup> , 10 m, dix connector on both ends, Water cooled
6260465C1	ROBOT 70-25-WH DIX	Zipper bag, 70 mm <sup>2</sup> , 25 m, dix connector on both ends, Water cooled

## 7 INTERCONNECTION CABLE BRACKETS



Ordering code	Additional info
SP800888	Works together with interconnection cables with corrugated sleeve. Kit includes an adapter plate for KUKA KR CYBERTECH series robots for 2nd joint attachment.
9370131	Works together with interconnection cables with corrugated sleeve. For each clamp (9370131) also 2x jaws are required (9370133)



Ordering code	SP008072	Metal attachment piece, two cable ties, for zipper bag
---------------	----------	--



## 8 EARTH RETURN CABLE



Ordering code	Description	Additional info
6184711	EARTH RETURN CABLE 70 mm <sup>2</sup> 5m	Dix connector for the power source, 5 m, 70 mm <sup>2</sup>
6184712	EARTH RETURN CABLE 70 mm <sup>2</sup> 10m	Dix connector for the power source, 10 m , 70 mm <sup>2</sup>
6184713	EARTH RETURN CABLE 70 mm <sup>2</sup> 15m	Dix connector for the power source, 15 m , 70 mm <sup>2</sup>

## 9 WIRE CONDUIT FOR WIRE SPOOLS

High quality wire conduit delivers the filler wire smoothly from wire spool to wire feeder. Male connectors on both ends fit to Kemppi feeder and Kemppi wire spool support. Order codes does not include female snap connector for wire spool holder or wire drum. It must be ordered separately. In case of stainless steel or aluminium, a separate chili liner is also required.

### WIRE CONDUITS (STANDARD LENGTH)



Ordering code	Description
SP600535	WIRE CONDUIT-1.8M ROBOT KEMPPi
SP600536	WIRE CONDUIT-3.0M ROBOT KEMPPi
SP800803	WIRE CONDUIT-4.0M ROBOT KEMPPi
SP600537	WIRE CONDUIT-5.0M ROBOT KEMPPi
SP600686	WIRE CONDUIT-8.0M ROBOT KEMPPi
SP600731	ADDITIONAL CHILI LINER KIT FOR STAINLESS STEEL AND ALUMINUM WELDING CASES



## 9 WIRE CONDUIT FOR WIRE DRUMS

Alternative solution for wire conduit when distance between wire feeder and wire drum is greater than 5 meters. NOTE: When ordering W005195 with the desired length, you also need snap connectors: two male (W005197) and one female (W005189).

### 9.1 WIRE CONDUITS (CUSTOM LENGTH)



Ordering code W005195

Custom length for your delivery (max. 27 m)

### 9.2 SNAP CONNECTOR FOR WIRE CONDUIT (MALE)



Ordering code W005197

Male connector for wire conduit, two pieces needed per conduit

### 9.3 SNAP CONNECTOR FOR DRUM OR SPOOL HOLDER (FEMALE)



Ordering code W005189

Female connector for the wire drum or spool holder



## 10 WIRE SPOOL HOLDER



Suitable for standard 15 kg wire coil. NOTE: Female connector for wire conduit not included. Must be ordered separately.

Ordering code	Description	Additional info
W007628	WIRE SPOOL SUPPORT RIGHT	wire spool holder
W007629	WIRE SPOOL SUPPORT LEFT	wire spool holder

## 11 PROTECTIVE COVER FOR WIRE SPOOL



Ordering code SP007940 Plastic cover for wire spool holder

## 12 FLOOR STAND FOR WIRE WIRE SPOOL HOLDER



Ordering code W007356 Floor stand for wire spool holder



## 13 WIRE FEEDER MOUNTING BRACKETS



Brackets for mounting the wire feeder on the robot's 3rd axis. The design is robot model specific. Order code includes metal plates. Insulation rings and Screws are not included if order code begins with W.

Robot brand	Robot model	Ordering code
ABB	IRB 1520ID	W014886
ABB	IRB 1600ID	W004138
ABB	IRB 2400/10	SP800713
ABB	IRB 2400/16	SP800713
ABB	IRB 2400L	W004135
Fanuc	100iC-7L	SP800991
Fanuc	100iC-8L	SP800991
Fanuc	100iC-12	SP800991
Fanuc	100iC-12S	SP800991
Fanuc	120iC	SP800991
Fanuc	120iC-12L	SP800991
Kawasaki	BA006N	W014755
Kawasaki	BA006L	W014755
Kawasaki	RA006L	W014821
Kawasaki	RA010N	W014821
Kawasaki	RA010L	W014821
Kawasaki	RA020N	W014821
KUKA	KR 5 ARC HW	SP801006
KUKA	KR 5-2 ARC HW	SP801006
KUKA	KR6 R1820 ARC HW	SP800872
KUKA	KR8 R1420 ARC HW	SP800872
KUKA	KR8 R1620 ARC HW	SP800872
KUKA	KR5 Arc	SP800707
KUKA	KR6-2	SP800810
KUKA	KR6 R1820	SP800707
KUKA	KR8 R1620	SP800810
KUKA	KR8 R2010	SP800810
KUKA	KR10 R1420	SP800810
MOTOMAN	GP25 - 12	SP800892
MOTOMAN	GP25	SP800892
MOTOMAN	MA2010	SP800892
MOTOMAN	MH50	SP800988
MOTOMAN	MH50-35II	SP800988
MOTOMAN	MH50-20II	SP800988
MOTOMAN	UP6	SP800997
MOTOMAN	EA1900	W004107



## 14 WISE PROCESSES



Ordering code	Description
6265013	WiseThin-A
9991011	WiseRoot-A
9991015	WiseFusion-A
9991010	WisePenetration-A

## 15 WELDING GUN PACKAGE



See robotic gun packages page 62.

## 16 WELDING GUN CLEANING STATION



See robotic gun packages page 86 more information.



## OPTIONAL ITEMS

### 17 REMOTE CONTROL PANEL



Ordering code	Description	Additional info
6200800	KF 62 Remote control panel	With 10-meter connecting cable

### 18 GAS FLOW KIT

Ordering code	Description	Additional info
SP600434	Gas flow kit	Monitors minimum limit of gas flow



- |   |   |
|---|---|
| <b>1</b> Power source                   | <b>9</b> Wire conduit                       |
| <b>2</b> Wire feeder                    | <b>10</b> Wire spool holder                 |
| <b>3</b> Wire feeder roller kit         | <b>11</b> Wire spool protective cover       |
| <b>4</b> Water cooling unit             | <b>12</b> Floor stand for wire spool holder |
| <b>5</b> Robot interface module         | <b>13</b> Wire feeder mounting bracket      |
| <b>6</b> Interconnection cables         | <b>14</b> Wise processes                    |
| <b>7</b> Interconnection cable brackets | <b>15</b> Welding gun package               |
| <b>8</b> Earth return cable             | <b>16</b> Welding gun cleaning station      |





# KempArc SYN

## Automated quality and productivity

If you are looking for a productive and reliable robotic welding solution, we have just the thing for you. The compact and powerful KempArc SYN 500 is designed for synergic MIG/MAG welding automation. Its excellent arc characteristics will deliver high quality welds. All common fieldbus protocols can be used for the robot interface.. KempArc SYN 500 is especially well suited for cost-effective retrofit cases and heavy duty applications, delivering 430 A at 100% duty cycle. It is available both in analogue and digital models for integration with different robotic control systems.

### BENEFITS

- Robot interface integrated in the power source
- Easy programming with the synergic welding programs and 90 memory channels
- Fast fieldbus-based communication guarantees integration with all common robot brands
- Available in digital and analogue models for varied integration possibilities
- Compact and lightweight wire feed mechanism



## 1 KEMPARC SYN 500 POWER SOURCE



Synergic MIG/MAG welding automation system, especially well-suited for cost-effective retrofit cases and heavy duty applications. KempArc SYN 500 is available in digital and analogue (AN) models for integration with different robotic control systems.

### TECHNICAL SPECIFICATIONS

Ordering code	6201500 / 6201500AN
Connection voltage 3~ 50/60 Hz	400 V -15...+20%
Fuse (delayed)	35 A
Minimum generator power	27kVA (60%) 20kVA (100%)
Welding range	10 ... 42 V
Open circuit voltage	50 V
Rated power 60% ED	26.1 kVA
Rated power 100% ED	20.3 kVA
Primary current 50% ED	I1max 40.0 A
Primary current 100% ED	I1 31.0 A
Connection cable size	6 mm <sup>2</sup>
Idle power (no load power)	25 W
Efficiency	87%
Power factor	0.9
Voltage supply for auxiliary devices	50 V
Auxiliary device supply fuse (X14, X15)	6.3 A delayed
Voltage supply for the cooling device	1-ph 400 VAC/250 VA
Max. welding voltage	46 V
Max. output current	500 A (60 %)
Operating temperature range	-20 ... +40 °C
External dimensions LxWxH	590 × 230 × 500 mm
Weight (no accessories)	37 kg
Degree of protection	IP23C
EMC class	A



### STAND FOR POWER SOURCE

Ordering code 6185295

For easy transport and keeping floor free under welder



## ② KEMPARC DT400 / DT400L / DT410L WIRE FEEDER



Wire feeder for automated welding with a reliable 4-roll wire feed mechanism and full metal feed rolls. DT400 can be mounted on the back of the robot arm or integrated with any mechanized welding system. A separate mounting bracket is required for mounting the wire feeder on robot. Wire feeder with Euro connector is available in right and left hand models (L) and PowerPin version is available in left hand version.

### TECHNICAL SPECIFICATIONS

	KEMPARC DT400 WIRE FEEDER	KEMPARC DT 410 L WIRE FEEDER
Ordering code	6203400 / 6203400L	6203410
Operating voltage	50 VDC	50 VDC
Rated power	100 W	100 W
Loadability	40°C 100%ED 500 A	40°C 100%ED 500 A
Wire feed speed	0...25 m/min	0...25 m/min
Filler wires	0.8...1.6 mm	0.8...1.6 mm
Welding gun connector	Euro	PowerPin
Operating temperature range	-20...+40°C	-20...+40°C
EMC	class A	class A
Degree of protection	n IP23S	n IP23S
External dimensions	269 x 175 x 169 mm	269 x 175 x 169 mm
Weight	4.5 kg	4.5 kg



### 3 FEED ROLL KITS FOR DT400 WIRE FEEDER



U = U Groove  
V = Plain V Groove  
VK = Knurled V Groove  
T = Trapezoid Groove  
HD = Heavy Duty kit (contains metal feed rolls)  
MC/FC = Metal/Flux Cored

Ordering code	Description
F000350	FE (MC/FC) V0.8-0.9 HD DURATORQUE KIT #3
F000351	FE (MC/FC) V1.0 HD DURATORQUE KIT #3
F000352	FE (MC/FC) V1.2 HD DURATORQUE KIT #3
F000353	FE (MC/FC) V1.6 HD DURATORQUE KIT #3
F000354	SS (FE) V0.8-0.9 HD DURATORQUE KIT #3
F000355	SS (FE) V1.0 HD DURATORQUE KIT #3
F000356	SS (FE) V1.2 HD DURATORQUE KIT #3
F000357	SS (FE) V1.6 HD DURATORQUE KIT #3
F000358	MC/FC VK1.0 HD DURATORQUE KIT #3
F000359	MC/FC VK1.2 HD DURATORQUE KIT #3
F000360	MC/FC VK1.4-1.6 HD DURATORQUE KIT #3
F000361	MC/FC VK2.0 HD DURATORQUE KIT #3
F000362	AL U1.0 HD DURATORQUE KIT #3
F000363	AL U1.2 HD DURATORQUE KIT #3
F000364	AL U1.6 HD DURATORQUE KIT #3



## 4 KEMPCOOL 10 COOLING UNIT



Cooling unit suitable for use with Kemppi KempArc welding equipment. KempCool 10 performs 1 kW of cooling power with a three liter tank that can be filled with 20%-40% ethanol/water mixture, or any other suitable antifreeze agent.

### TECHNICAL SPECIFICATIONS

Ordering code	6208100
Connection voltage 3~ 50/60 Hz	400 V -15...+20%
Rated power	250 W (100 %)
Rated power 100% ED	250 W
Cooling liquid	20 - 40% Monopropylenglycol - water
Max. pressure at output	0.4 MPa
Operating temperature range	-20 ... +40 °C
External dimensions LxWxH	570 × 230 × 280 mm
Weight (no accessories)	11 kg
Degree of protection	IP23S
EMC class	A
Cooler tank volume	3 l
Cooling power	1 kW
Storage temperature range	-40 ... +60 °C

### COOLING LIQUID

Ordering code	SP9810765	10 liter can
---------------	-----------	--------------



## 5 ROBOT INTERFACE CARDS

Fieldbus communication between power source and robot controller is enabled with modules. The protocol can be chosen based on customer preference. Modules are placed inside the KempArc robot interface chassis.



Ordering code	Description
9774120CAN	INTERFACE CARD CAN OPEN
9774120DEV	FIELD BUS ADAPTER DEVICENET
9774120ETC	FIELD BUS INTERFACE ETHERCAT
9774120ETH	FIELD BUS ADAPTER ETHERNET
9774120IBC	FIELD BUS ADAPTER INTERBUS COPPER
9774120IBO	FIELD BUS ADAPTER INTERBUS OPTICAL
9774120PRF	FIELD BUS ADAPTER PROFIBUS
9774120PRN	FIELD BUS ADAPTER PROFINET



## 6 INTERCONNECTION CABLES



The interconnection cable set contains several cables and hoses. The cable set is used for delivering the welding power, shielding gas, cooling liquid, and control signals from the welding power source to the wire feeder. Interconnection cable sets are available in zipper bags or in corrugated sleeves.



### GAS COOLED CABLE SETS

Ordering code	Description	Additional info
6260441	ROBOT 70-5-GH	Corrugated sleeve, 70 mm <sup>2</sup> , 5m, Dix connector on both ends, Gas cooled
6260445	ROBOT 70-10-GH	Corrugated sleeve, 70 mm <sup>2</sup> , 10m, Dix connector on both ends, Gas cooled
6260446	ROBOT 70-5-GH DIX	Zipper bag, 70 mm <sup>2</sup> , 5 m, dix connector on both ends, Gas cooled
6260447	ROBOT 70-10-GH DIX	Zipper bag, 70 mm <sup>2</sup> , 10 m, dix connector on both ends, Gas cooled
6260442	ROBOT 70-5-GH CABLE SHOE	Suitable for DT 410 feeder, PowerPin connector for welding gun, cable shoe for feeder connection and dix for power source, 5 m, Gas cooled
6260443	ROBOT 70-10-GH CABLE SHOE	Suitable for DT 410 feeder, PowerPin connector for welding gun, cable shoe for feeder connection and dix for power source, 10 m, Gas cooled

### WATER COOLED CABLE SETS

Ordering code	Description	Additional info
6260461	ROBOT 95-5-WH	Corrugated sleeve, 95 mm <sup>2</sup> , 5m, Dix connector on both ends, Water cooled
6260465	ROBOT 95-10-WH	Corrugated sleeve, 95 mm <sup>2</sup> , 10m, Dix connector on both ends, Water cooled
6260465C2	ROBOT 95-30-WH	Corrugated sleeve, 95 mm <sup>2</sup> , 30m, Dix connector on both ends, Water cooled
6260465C3	ROBOT 95-20-WH	Corrugated sleeve, 95 mm <sup>2</sup> , 20m, Dix connector on both ends, Water cooled
6260465C4	ROBOT 95-15-WH	Corrugated sleeve, 95 mm <sup>2</sup> , 15m, Dix connector on both ends, Water cooled
6260478	ROBOT 70-5-WH DIX	Zipper bag, 70 mm <sup>2</sup> , 5 m, dix connector on both ends, Water cooled
6260479	ROBOT 70-10-WH DIX	Zipper bag, 70 mm <sup>2</sup> , 10 m, dix connector on both ends, Water cooled
6260465C1	ROBOT 70-25-WH DIX	Zipper bag, 70 mm <sup>2</sup> , 25 m, dix connector on both ends, Water cooled



## 7 INTERCONNECTION CABLE BRACKETS



Ordering code	Additional info
SP800888	Works together with interconnection cables with corrugated sleeve. Kit includes an adapter plate for KUKA KR CYBERTECH series robots for 2nd joint attachment.
9370131	Works together with interconnection cables with corrugated sleeve. For each clamp (9370131) also 2x jaws are required (9370133)



Ordering code	SP008072	Metal attachment piece, two cable ties, for zipper bag
---------------	----------	--

## 8 EARTH RETURN CABLE



Ordering code	Description	Additional info
6184711	EARTH RETURN CABLE 70 MM <sup>2</sup> 5M	Dix connector for the power source, 5 m , 70 mm <sup>2</sup>
6184712	EARTH RETURN CABLE 70 MM <sup>2</sup> 10M	Dix connector for the power source, 10 m , 70 mm <sup>2</sup>
6184713	EARTH RETURN CABLE 70 MM <sup>2</sup> 15M	Dix connector for the power source, 15 m , 70 mm <sup>2</sup>





## 9 WIRE CONDUIT FOR WIRE SPOOLS

High quality wire conduit delivers the filler wire smoothly from wire spool to wire feeder. Male connectors on both ends fit to Kemppi feeder and Kemppi wire spool support. Order codes do not include female snap connector for wire spool holder or wire drum. It must be ordered separately. In case of stainless steel or aluminium, a separate chili liner is also required.

### WIRE CONDUITS (STANDARD LENGTH)



Ordering code	Description
SP600535	WIRE CONDUIT-1.8M ROBOT KEMPPI
SP600536	WIRE CONDUIT-3.0M ROBOT KEMPPI
SP800803	WIRE CONDUIT-4.0M ROBOT KEMPPI
SP600537	WIRE CONDUIT-5.0M ROBOT KEMPPI
SP600686	WIRE CONDUIT-8.0M ROBOT KEMPPI
SP600731	ADDITIONAL CHILI LINER KIT FOR STAINLESS STEEL AND ALUMINUM WELDING CASES



## 9 WIRE CONDUIT FOR WIRE DRUMS

Alternative solution for wire conduit when distance between wire feeder and wire drum is greater than 5 meters. NOTE: When ordering W005195 with the desired length, you also need snap connectors: two male (W005197) and one female (W005189).

### 9.1 WIRE CONDUITS (CUSTOM LENGTH)



Ordering code W005195

Custom length for your delivery (max. 27 m)

### 9.2 SNAP CONNECTOR FOR WIRE CONDUIT (MALE)



Ordering code W005197

Male connector for wire conduit, two pieces needed per conduit

### 9.3 SNAP CONNECTOR FOR DRUM OR SPOOL HOLDER (FEMALE)



Ordering code W005189

Female connector for the wire drum or spool holder



## 10 WIRE SPOOL HOLDER



Suitable for standard 15 kg wire coil. NOTE: Female connector for wire conduit not included. Must be ordered separately.

Ordering code	Description	Additional info
W007628	WIRE SPOOL SUPPORT RIGHT	wire spool holder
W007629	WIRE SPOOL SUPPORT LEFT	wire spool holder

## 11 PROTECTIVE COVER FOR WIRE SPOOL



Ordering code SP007940 Plastic cover for wire spool holder

## 12 FLOOR STAND FOR WIRE SPOOL HOLDER



Ordering code W007356 Floor stand for wire spool holder



## 13 WIRE FEEDER MOUNTING BRACKETS



Brackets for mounting the wire feeder on the robot's 3rd axis. The design is robot model specific. Order code includes metal plates. Insulation rings and Screws are not included if order code begins with W.

Robot brand	Robot model	Ordering code
ABB	IRB 1520ID	W014886
ABB	IRB 1600ID	W004138
ABB	IRB 2400/10	SP800713
ABB	IRB 2400/16	SP800713
ABB	IRB 2400L	W004135
Fanuc	100iC-7L	SP800991
Fanuc	100iC-8L	SP800991
Fanuc	100iC-12	SP800991
Fanuc	100iC-12S	SP800991
Fanuc	120iC	SP800991
Fanuc	120iC-12L	SP800991
Kawasaki	BA006N	W014755
Kawasaki	BA006L	W014755
Kawasaki	RA006L	W014821
Kawasaki	RA010N	W014821
Kawasaki	RA010L	W014821
Kawasaki	RA020N	W014821
KUKA	KR 5 ARC HW	SP801006
KUKA	KR 5-2 ARC HW	SP801006
KUKA	KR6 R1820 ARC HW	SP800872
KUKA	KR8 R1420 ARC HW	SP800872
KUKA	KR8 R1620 ARC HW	SP800872
KUKA	KR5 Arc	SP800707
KUKA	KR6-2	SP800810
KUKA	KR6 R1820	SP800707
KUKA	KR8 R1620	SP800810
KUKA	KR8 R2010	SP800810
KUKA	KR10 R1420	SP800810
MOTOMAN	GP25 - 12	SP800892
MOTOMAN	GP25	SP800892
MOTOMAN	MA2010	SP800892
MOTOMAN	MH50	SP800988
MOTOMAN	MH50-35II	SP800988
MOTOMAN	MH50-20II	SP800988
MOTOMAN	UP6	SP800997
MOTOMAN	EA1900	W004107



## 14 WISE PROCESSES



Ordering code	Description
6265013	WiseThin-A
9991011	WiseRoot-A

## 15 WELDING GUN PACKAGE



See robotic gun packages page 62

## 16 WELDING GUN CLEANING STATION



See robotic gun packages page 86 more information.

Ordering code	SP600674	Robot gun cleaning station
---------------	----------	----------------------------

## OPTIONAL ITEMS

### 17 GAS FLOW KIT

Ordering code	Description	Additional info
SP600434	Gas flow kit	Monitors minimum limit of gas flow

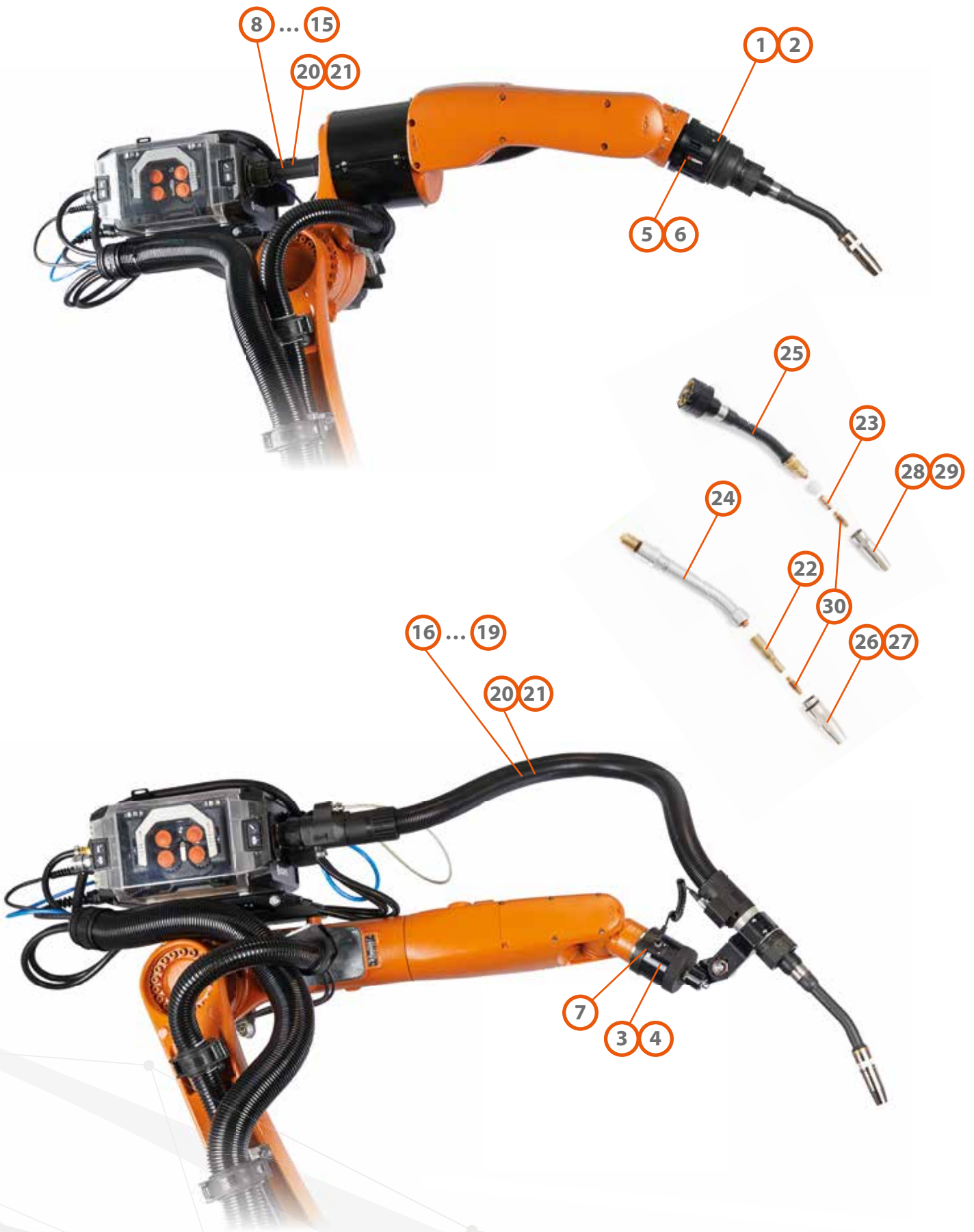



# **Robotic Gun packages**

A perfect welding gun system for robotic arc welding consist of gun neck with a contact tip holder, a gas nozzle and a cable assembly. Robotic gun can be mounted on suitable Kemppi Gun Mount.

Accurate TCP location contributes to constant and reliable welding results. Robust design constructed from centralized inner tube & stainless steel made outer tube, guarantees best possible usability during daily operations and minimizes the risk of damages to system in case of collisions. Low maintenance need and easy to change components increase system availability.

Four standard swan neck designs are available for both gas and water cooled variants. Engineered designs available at request.

Robotic gun cleaning station is available for Kemppi robotic gun packages.

The choice of the correct robotic gun package is based mainly on robot brand and model and required cooling. The following tables guide you in choosing the correct items based on the application.

Use table 1 to select the gun mount type, flange, cable assembly and the liner.

<b>Table 1</b>	Start from the top, proceed line by line in numerical order											
Robot upper arm design	Hollow wrist								Non hollow wrist			
Cooling type	Gas				Water				Gas		Water	
Gun mount type	T1 g <b>1</b>		T3 g <b>2</b>		T1 w <b>1</b>		T3 w <b>2</b>		T2 <b>3</b>	T4 <b>4</b>	T2 <b>3</b>	T4 <b>4</b>
Flange type based on robot model	<b>5</b>		<b>6</b>		<b>5</b>		<b>6</b>		<b>7</b>		<b>7</b>	
Wire feeder connector type	euro	pp	euro	pp	euro	pp	euro	pp	euro	pp	euro	pp
Cable assembly based on robot model	<b>8</b>	<b>9</b>	<b>10</b>	<b>11</b>	<b>12</b>	<b>13</b>	<b>14</b>	<b>15</b>	<b>16</b>	<b>17</b>	<b>18</b>	<b>19</b>
Liner for cable assembly	<b>20</b>	<b>21</b>	<b>20</b>	<b>21</b>	<b>20</b>	<b>21</b>	<b>20</b>	<b>21</b>	<b>20</b>	<b>21</b>	<b>20</b>	<b>21</b>

Use table 2 to select the gun neck, gas nozzle, contact tip holder and the contact tip.

<b>Table 2</b>	Start from the top, proceed line by line in numerical order			
Cooling type	Gas		Water	
Contact tip holder	<b>22</b>		<b>23</b>	
Neck form	<b>24</b>		<b>25</b>	
Gas nozzle form	conical <b>26</b>	bottle <b>27</b>	conical <b>28</b>	bottle <b>29</b>
Contact tip	<b>30</b>			



## ① GUN MOUNT T1

Kempfi T1 Gun Mount for robotic guns is meant to be used with hollow wrist type robot models where the cable assembly is run through the 6th axis of the robot.

T1 Gun Mount is equipped with collision sensors and signal is to be connected with robot controller. Collision detection is an essential function in arc welding robotics and helps to avoid or minimize damage to welding equipment, work piece or tooling in case of gun neck makes unplanned contact with its surroundings. Separate versions available for water cooled and gas cooled applications. Robot specific flange is required for final assembly, see 5.



Ordering code	Description	Additional info
SP600588	Robot gun mount/Collision sensor T1 W	For water cooled systems



Ordering code	Description	Additional info
SP600589	Robot gun mount/Collision sensor T1 G	For gas cooled systems

## ② GUN MOUNT T3

Kempfi T3 Gun Mount for robotic guns is meant to be used with hollow wrist type robot models where the cable assembly is run through the 6th axis of the robot.

T3 Gun Mount is not equipped with collision sensors and so the robot model, which is used, should have software functionalities itself to handle collision detection. Collision detection is an essential function in arc welding robotics and helps to avoid or minimize damage to welding equipment, work piece or tooling in case of gun neck makes unplanned contact with its surroundings. Separate versions available for water cooled and gas cooled applications. Robot specific flange is required for final assembly, see 6.



Ordering code	Description	Additional info
SP600574	Robot gun mount T3 W	for water cooled systems

Ordering code	Description	Additional info
SP600575	Robot gun mount T3 G	for gas cooled systems





## 3 GUN MOUNT T2

Kempfi T2 Gun Mount for robotic guns is meant to be used with non hollow wrist type robot models. T2 Gun Mount is equipped with collision sensors and signal is to be connected with robot controller. Collision detection is an essential function in arc welding robotics and helps to avoid or minimize damage to welding equipment, work piece or tooling in case of gun neck makes unplanned contact with its surroundings. A separate segment holder is used to attach the T2 gun mount to the robot. Robot specific flange is required for final assembly, see 7.



Ordering code	Description	Additional info
SP600605	Robot gun mount/Collision sensor T2 L	Default version for normal guns
SP600606	Robot gun mount/Collision sensor T2 XL	For tandem welding guns

Ordering code	Description	Additional info
SP600608	Segment holder for gun mount T2	Adjustable gun neck mounting angle

## 4 GUN MOUNT T4

Kempfi T4 Gun Mount for robotic guns is meant to be used with non hollow wrist type robot models. T4 Gun Mount is not equipped with collision sensors and so the robot model, which is used, should have software functionalities itself to handle collision detection. Collision detection is an essential function in arc welding robotics and helps to avoid or minimize damage to welding equipment, work piece or tooling in case of gun neck makes unplanned contact with its surroundings. T4 Gun Mount T4 Gun Mount consist of upper and lower bracket parts. Robot specific flange is required for final assembly, see 7.



Ordering code	Description	Additional info
SP600604	Robot gun mount T4	Adjustable gun neck mounting angle



## 5 ADAPTER FLANGES FOR T1 GUN MOUNTS

The choice of the adapter flange is based on exact robot brand and model. Flanges for T1 gun mounts are meant for HW-robot models and fit both T1 W and T1 G mount models.



Robot brand	Robot model	Ordering code
ABB	IRB 1520ID	SP600570
ABB	IRB 1600ID	SP600570
ABB	1660ID 6/155	SP600724
ABB	IRB 2600ID-15/1,85	SP600724
ABB	IRB 2600ID-8/2,00	SP600724
Fanuc	100iC-7L	SP600583 + SP600573
Fanuc	100iC-8L	SP600583 + SP600573
Fanuc	100iC-12	SP600583 + SP600573
Fanuc	100iC-12S	SP600583 + SP600573
Fanuc	120iC	SP600583 + SP600573
Fanuc	120iC-12L	SP600583 + SP600573
Fanuc	100iD	SP600800
Fanuc	100iD-10L 100iD-10L	SP600800
Kawasaki	BA006N	SP600695
Kawasaki	BA006L	SP600695
KUKA	KR 5 ARC HW	SP600582
KUKA	KR 5-2 ARC HW	SP600582
KUKA	KR6 R1820 ARC HW	SP600582
KUKA	KR8 R1420 ARC HW	SP600582
KUKA	KR8 R1620 ARC HW	SP600582
KUKA	KR8 R2100 ARC HW	SP600582
MOTOMAN	GP12	SP600648
MOTOMAN	GP25	SP600648
MOTOMAN	GP25 - 12	SP600648
MOTOMAN	MA1440	SP600648
MOTOMAN	MA2010	SP600648
MOTOMAN	VA1400	SP600580
MOTOMAN	MA1550	SP600580
MOTOMAN	MA1800	SP600580
MOTOMAN	MA1900	SP600580
MOTOMAN	EA1400N	SP600580
MOTOMAN	EA1900N	SP600580
MOTOMAN	EA1900	SP600580



## 6 ADAPTER FLANGES FOR T3 GUN MOUNTS

The choice of the adapter flange is based on exact robot brand and model. Flanges for T3 gun mounts are meant for HW-robot models and fit both T3 W and T3 G mount models.



Robot brand	Robot model	Ordering code
ABB	IRB 1520ID	SP600570
ABB	IRB 1600ID	SP600570
ABB	IRB 2600ID-15/1,85	SP600571
ABB	IRB 2600ID-8/2.00	SP600571
Fanuc	100iC-7L	SP600572 + 600573
Fanuc	100iC-8L	SP600572 + 600573
Fanuc	100iC-12	SP600572 + 600573
Fanuc	100iC-12S	SP600572 + 600573
Fanuc	120iC	SP600572 + 600573
Fanuc	120iC-12L	SP600572 + 600573
Fanuc	100iD	SP600801
Fanuc	100iD-10L	SP600801



## 7 ADAPTER FLANGES FOR T2 AND T4 GUN MOUNTS

The choice of the adapter flange is based on exact robot brand and model. Flanges for T2 / T4 gun mounts are meant for non-HW-robot models.



Robot brand	Robot model	Ordering code
ABB	IRB 2400/10	SP600634
ABB	IRB 2400/16	SP600634
ABB	IRB 2400L	SP600639
ABB	IRB 1600-X/120	SP600639
ABB	IRB 1600-X/145	SP600639
ABB	IRB 2600-12/165	SP600640
ABB	2600-12/185	SP600640
ABB	2600-20/165	SP600640
ABB	IRB 4400-60/195	SP600637
ABB	IRB 4600-20/205	SP600640
ABB	IRB 4600-40/255	SP600637
ABB	IRB 4600-45/205	SP600637
ABB	IRB 4600-60/205	SP600637
Kawasaki	RA005L	SP600633
Kawasaki	RA006L	SP600639
Kawasaki	RA010N	SP600639
Kawasaki	RA010L	SP600635
Kawasaki	RA020N	SP600635
KUKA	KR5 Arc	SP600639
KUKA	KR6-2	SP600639
KUKA	KR6 R1820	SP600633
KUKA	KR8 R1620	SP600633
KUKA	KR8 R2010	SP600634
KUKA	KR10 R1420	SP600633
MOTOMAN	MH50	SP600636
MOTOMAN	MH50-35II	SP600636
MOTOMAN	MH50II	SP600636
MOTOMAN	MH50-20II	SP600639
MOTOMAN	MH6	SP600639
MOTOMAN	MH6S	SP600639
MOTOMAN	HP20D	SP600639
MOTOMAN	HP20D-6	SP600639
MOTOMAN	UP6	SP600639
Universal robots	UR10	SP600634
Universal robots	UR5	SP600634
Hyundai	HA006	SP600639
FLANGE	ISO 9409-1A31	SP600633
FLANGE	ISO 9409-1-A40	5SP600639
FLANGE	ISO 9409-1A50	SP600634
FLANGE	ISO 9409-1A63	SP600635
FLANGE	ISO 9409-1A80	SP600636
FLANGE	ISO 9409-1A100	SP600637
FLANGE	ISO 9409-1A125	SP600603



## 8 CABLE ASSEMBLIES FOR HW-ROBOTS, GAS COOLED, T1 MOUNT AND EURO CONNECTOR

Cable assemblies for HW-robots must be accurate in length. Cable lengths are designed for certain wire feeder and bracket combination. For additional combinations consult Kemppi sales.

Robot brand	Robot model	Type	Ordering code (A7)	Length
ABB	IRB 1520ID	T1	SP600716	1,07m
Fanuc	100iC-8L	T1	SP600811	1,39m
Fanuc	100iD	T1	SP600744	0,94m
Kawasaki	BA006N	T1	SP600698	1,01m
Kawasaki	BA006L	T1	SP600737	1,34m
KUKA	KR6 R1820 ARC HW	T1	SP600708	1,11m
MOTOMAN	GP12	T1	SP600658	0,97m
MOTOMAN	GP25 - 12	T1	SP600720	1,39m
MOTOMAN	MA1440	T1	SP600658	0,97m
MOTOMAN	MA2010	T1	SP600720	1,39m
MOTOMAN	EA1400N	T1	SP600590	1,05m

Robot brand	Robot model	Type	Ordering code (A7)	Length
KUKA	KR 5 ARC HW	T1	SP600710	0,99m
KUKA	KR 5-2 ARC HW	T1	SP600710	0,99m

## 9 CABLE ASSEMBLIES FOR HW-ROBOTS, GAS COOLED, T1 MOUNT AND POWER PIN CONNECTOR

Cable assemblies for HW-robots must be accurate in length. Cable lengths are designed for certain wire feeder - bracket combination. For additional combinations consult Kemppi sales.

Robot brand	Robot model	Type	Ordering code (A7)	Length
Fanuc	100iD	T1	SP600746	0,95m
MOTOMAN	EA1400N	T1	SP600590	1,05m
MOTOMAN	EA1900N	T1	SP600591	1,34m



## 10 CABLE ASSEMBLIES FOR HW-ROBOTS, GAS COOLED, T3 MOUNT AND EURO CONNECTOR

Cable assemblies for HW-robots must be accurate in length. Cable lengths are designed for certain wire feeder - bracket combination. For additional combinations consult Kemppi sales.

Robot brand	Robot model	Type	Ordering code (A7)	Length
ABB	IRB 1520ID	T3	SP600730	1,03m
Fanuc	100iC-8L	T3	SP600680	1,39m
Fanuc	100iC-12	T3	SP600679	0,94m
Fanuc	100iD	T3	SP600748	0,86m

## 11 CABLE ASSEMBLIES FOR HW-ROBOTS, GAS COOLED, T3 MOUNT AND POWER PIN CONNECTOR

Cable assemblies for HW-robots must be accurate in length. Cable lengths are designed for certain wire feeder - bracket combination. For additional combinations consult Kemppi sales.

Robot brand	Robot model	Type	Ordering code (A7)	Length
ABB	IRB 1520ID	T3	SP600677	1,05m
ABB	IRB 1600ID	T3	SP600676	1,12m
Fanuc	100iC-12	T3	SP600576	0,92m
Fanuc	100iD	T3	SP600750	0,87m



## 12 CABLE ASSEMBLIES FOR HW-ROBOTS, WATER COOLED, T1 MOUNT AND EURO CONNECTOR



Cable assemblies for HW-robots must be accurate in length. Cable lengths are designed for certain wire feeder - bracket combination. For additional combinations consult Kemppi sales.

Robot brand	Robot model	Type	Ordering code (A7)	Length	Ordering code (Kemparc)	Length
ABB	IRB 1660ID	T1	SP600721	1,10m		
ABB	IRB 2600ID-15/1,85	T1	SP600722	1,16m		
ABB	IRB 2600ID-8/2.00	T1	SP600723	1,38m		
Fanuc	100iC-8L	T1	SP600810	1,39m		
Fanuc	120iC	T1	SP600736	1,14m		
Fanuc	100iD	T1	SP600743	0,94m		
Kawasaki	BA006N	T1	SP600675	1,01m		
Kawasaki	BA006L	T1	SP600735	1,34m		
KUKA	KR 5 ARC HW	T1	SP600670	0,98m		
KUKA	KR 5-2 ARC HW	T1	SP600670	0,98m		
KUKA	KR6 R1820 ARC HW	T1	SP600699	1,11m	SP600697	1,15m
KUKA	KR8 R1420 ARC HW	T1	SP600688	0,91m	SP600702	0,94m
KUKA	KR8 R1620 ARC HW	T1	SP600688	0,91m	SP600702	0,94m
KUKA	KR8 R2100 ARC HW	T1	SP600718	0,99m		
KUKA	KR16 Arc HW	T1	SP600649	1,10m		
MOTOMAN	GP12	T1	SP600650	0,97m		
MOTOMAN	GP25 - 12	T1	SP600709	1,39m		
MOTOMAN	MA1440	T1	SP600650	0,97m		
MOTOMAN	MA2010	T1	SP600709	1,39m		

## 13 CABLE ASSEMBLIES FOR HW-ROBOTS, WATER COOLED, T1 MOUNT AND POWER PIN CONNECTOR

Cable assemblies for HW-robots must be accurate in length. Cable lengths are designed for certain wire feeder - bracket combination. For additional combinations consult Kemppi sales.

Robot brand	Robot model	Type	Ordering code (A7)	Length
Fanuc	100iC-7L	T1	SP600593	1,17m
Fanuc	100iD	T1	SP600745	0,95m
MOTOMAN	EA1400N	T1	SP600594	1,05m
MOTOMAN	EA1900N	T1	SP600595	1,34m



## 14 CABLE ASSEMBLIES FOR HW-ROBOTS, WATER COOLED, T3 MOUNT AND EURO CONNECTOR

Cable assemblies for HW-robots must be accurate in length. Cable lengths are designed for certain wire feeder - bracket combination. For additional combinations consult Kemppi sales.

Robot brand	Robot model	Type	Ordering code (A7)	Length	Ordering code (Kemparc)
ABB	IRB 1520ID	T3	SP600578	1,03m	SP600660
ABB	IRB 1600ID	T3			SP600673
Fanuc	100iC-7L	T3	SP600706	1,14m	
Fanuc	100iC-8L	T3	SP600812	1,39m	
Fanuc	100iC-12	T3	SP600577	0,92m	
Fanuc	120iC	T3	SP600641	1,05m	
Fanuc	120iC-12L	T3	SP600719	1,34m	
Fanuc	100iD	T3	SP600747	0,86m	

## 15 CABLE ASSEMBLIES FOR HW-ROBOTS, WATER COOLED, T3 MOUNT AND POWER PIN CONNECTOR

Cable assemblies for HW-robots must be accurate in length. Cable lengths are designed for certain wire feeder - bracket combination. For additional combinations consult Kemppi sales.

Robot brand	Robot model	Type	Ordering code (A7)
Fanuc	100iD	T3	SP600749





## 16 CABLE ASSEMBLIES FOR NON-HW-ROBOTS, GAS COOLED, T2/T4 MOUNT AND EURO CONNECTOR

Cable assemblies for non-HW-robots are selected from standard lengths. A dimensional drawing showing distance from wire feeder front face to robot 6th axis is required for cable assembly length selection. For additional lengths consult Kempfi sales.

Robot brand	Robot model	Type	Ordering code (A7)	Length
ABB	IRB 2400/10	T2	SP600712	0,90m
ABB	IRB 2400/16	T2	SP600712	0,90m
ABB	IRB 2400L	T2	SP600694	1,10m
Kawasaki	BA006L	T2	SP600693	1,35m
Kawasaki	RA010N	T2	SP600694	1,10m
Kawasaki	RA010L	T2	SP600693	1,35m
Kawasaki	RA020N	T2	SP600694	1,10m
KUKA	KR5 Arc	T2	SP600694	1,10m
KUKA	KR6-2	T2	SP600694	1,10m
KUKA	KR6 R1820	T2	SP600694	1,10m
KUKA	KR8 R1620	T2	SP600712	0,90m
KUKA	KR10 R1420	T2	SP600712	0,90m
MOTOMAN	MH50	T2	SP600693	1,35m
MOTOMAN	MH50-35II	T2	SP600692	1,5m
MOTOMAN	MH50-20II	T2	SP600728	2m
MOTOMAN	HP20D	T2	SP600694	1,1m
MOTOMAN	HP20D-6	T2	SP600693	1,35m
MOTOMAN	UP6	T2	SP600712	0,90m
Universal Robot	UR	T2	SP600742	3,25m

CABLE ASSEMBLY	T2/T4 G EURO		SP600712	1,10m
CABLE ASSEMBLY	T2/T4 G EURO		SP600693	1,35m
CABLE ASSEMBLY	T2/T4 G EURO		SP600692	1,50m
CABLE ASSEMBLY	T2/T4 G EURO		SP600691	1,60m
CABLE ASSEMBLY	T2/T4 G EURO		SP600712	0,90m
CABLE ASSEMBLY	T2/T4 G EURO		SP600728	2,00m
CABLE ASSEMBLY	T2/T4 G EURO		SP600742	3,25m

## 17 CABLE ASSEMBLIES FOR NON-HW-ROBOTS, GAS COOLED, T2/T4 MOUNT AND POWER PIN CONNECTOR

Cable assemblies for non-HW-robots are selected from standard lengths. A dimensional drawing showing distance from wire feeder front face to robot 6th axis is required for cable assembly length selection. For additional lengths consult Kempfi sales.



## 18 CABLE ASSEMBLIES FOR NON-HW-ROBOTS, WATER COOLED, T2/T4 MOUNT AND EURO CONNECTOR



Cable assemblies for non-HW-robots are selected from standard lengths. A dimensional drawing showing distance from wire feeder front face to robot 6th axis is required for cable assembly length selection. For additional lengths consult Kemppi sales.

Robot brand	Robot model	Type	Ordering code (A7)	Length
ABB	IRB 2400/10	T2	SP600711	0,90m
ABB	IRB 2400/16	T2	SP600711	0,90m
ABB	IRB 2400L	T2	SP600651	1,10m
Kawasaki	RA006L	T2	SP600652	1,35m
Kawasaki	RA010N	T2	SP600651	1,10m
Kawasaki	RA010L	T2	SP600652	1,35m
Kawasaki	RA020N	T2	SP600651	1,10m
KUKA	KR5 Arc	T2	SP600651	1,10m
KUKA	KR6-2	T2	SP600651	1,10m
KUKA	KR6 R1820	T2	SP600651	1,10m
KUKA	KR8 R1620	T2	SP600711	0,90m
KUKA	KR10 R1420	T2	SP600711	0,90m
MOTOMAN	MH50	T2	SP600652	1,35m
MOTOMAN	MH50-35II	T2	SP600653	1,5m
MOTOMAN	MH50-20II	T2	SP600729	2m
MOTOMAN	HP20D	T2	SP600651	1,1m
MOTOMAN	HP20D-6	T2	SP600652	1,35m
MOTOMAN	UP6	T2	SP600711	0,9m

CABLE ASSEMBLY	T2/T4 G EURO		SP600711	0,90m
CABLE ASSEMBLY	T2/T4 G EURO		SP600673	1,00m
CABLE ASSEMBLY	T2/T4 G EURO		SP600651	1,10m
CABLE ASSEMBLY	T2/T4 G EURO		SP600685	1,20m
CABLE ASSEMBLY	T2/T4 G EURO		SP600652	1,35m
CABLE ASSEMBLY	T2/T4 G EURO		SP600653	1,50m
CABLE ASSEMBLY	T2/T4 G EURO		SP600654	1,60m
CABLE ASSEMBLY	T2/T4 G EURO		SP600729	2,00m
CABLE ASSEMBLY	T2/T4 G EURO		SP600705	3,25m
CABLE ASSEMBLY	T2/T4 G EURO		SP600717	4,00m



When using T2 cable assembly and the seam searching function is using the filler wire as the sensing tool, there might be a request to guarantee certain fixed stick-out length for wire during seam searching operation. For these applications Kemppi offers three cable assemblies with additional wire break module. Operation principle: Pneumatic valve releases a piston, which clamps the wire inside the cable assembly holder part. Requires an additional neck liner item: SP600564 for 1.0-1.2 mm wires.



Ordering code	Description	Additional info
SP600656	CABLE ASSEMBLY T2 W EURO 1.35M WIRE BRAKE	
SP600655	CABLE ASSEMBLY T2 W EURO 1.10M WIRE BRAKE	
SP600657	CABLE ASSEMBLY T2 W EURO 1.50M WIRE BRAKE	
SP600564	Neckliner T2 / T4	Steel liner. Required when wire break is used

## 19 CABLE ASSEMBLIES FOR NON-HW-ROBOTS, WATER COOLED, T2/T4 MOUNT AND POWER PIN CONNECTOR

Cable assemblies for non-HW-robots are selected from standard lengths. A dimensional drawing showing distance from wire feeder front face to robot 6th axis is required for cable assembly length selection. For additional lengths consult Kemppi sales.



## 20 WIRE LINERS FOR EURO CONNECTORS

Kemppi gun liners are strong, durable and efficient. Designed to suit specific filler wire materials and applications, Kemppi liners support the filler wire and ensure reliable delivery to the welding arc. Steel spiral liners are suitable for welding solid and cored filler wires of corresponding wire diameter. Kemppi DL Chili -Teflon liners are the latest solution for reliable feeding of aluminum, stainless steel, acid-resistant and solid steel filler wires. Kemppi's patented technology, two layer DL Chili liner material significantly reduces friction losses between the filler wire material and liner wall, ensuring reliable and worry-free feeding for listed wires types.



Ordering code	Description	Additional info
SP600666	LINER CHILI HP 2.0/4.7 2.5M ROBOT EU	
SP600725	LINER STEEL 1.6/4.6 2M ROBOT EU	
SP600738	LINER CHILI HP 2.0/4.7 4.0M ROBOT EU	
SP600740	LINER STEEL 1.6/4.6 4M ROBOT EU	

## 21 WIRE LINERS FOR POWER PIN CONNECTORS

Kemppi gun liners are strong, durable and efficient. Designed to suit specific filler wire materials and applications, Kemppi liners support the filler wire and ensure reliable delivery to the welding arc. Steel spiral liners are suitable for welding solid and cored filler wires of corresponding wire diameter. Kemppi DL Chili -Teflon liners are the latest solution for reliable feeding of aluminum, stainless steel, acid-resistant and solid steel filler wires. Kemppi's patented technology, two layer DL Chili liner material significantly reduces friction losses between the filler wire material and liner wall, ensuring reliable and worry-free feeding for listed wires types.



Ordering code	Description	Additional info
SP600668	LINER CHILI HP 2.0/4.7 2.5 M ROBOT PP	
SP600726	LINER STEEL 1.6/4.6 2M ROBOT PP	
SP600739	LINER CHILI HP 2.0/4.7 4.0M ROBOT PP	
SP600741	LINER STEEL 1.6/4.6 4M ROBOT PP	



## 22 CONTACT TIP HOLDER FOR GAS COOLED GUN

Features:

- Beryllium/Copper mix for optimal material properties
- Less spatter sensitive
- Massive, rugged and long design
- Better gas cooling through long gas flowing way
- Better gas protection (laminar flow) – see bores in pic
- Very good current transition
- Interrupted thread hence less dirt sensitive – better to clean
- Spanner flat area for easy opening/tightening operation



Ordering code	Description	Additional info
SP600629	CONTACT TIP ADAPTER M8 500-G	for gas cooled necks

## 23 CONTACT TIP HOLDER FOR WATER COOLED GUN



Ordering code	Description	Additional info
SP600560	CONTACT TIP ADAPTER M8 500-W	for water cooled necks



## 24 WELDING GUN NECKS FOR GAS COOLED SYSTEMS



Ordering code	Description	Additional info
SP600621	GUN NECK 500-G 0°	
SP600622	GUN NECK 500-G 22°	Recommended as default
SP600623	GUN NECK 500-G 35°	
SP600624	GUN NECK 500-G 45°	

### TECHNICAL SPECIFICATIONS

Loadability	100%ED 500 A / CO <sub>2</sub> , 100%ED 400 A / M <sup>21</sup>
Filler wires	0.8–1.6 mm
Gas flow	10–30 liters
Weight	0.9 kg

EN 60974-7. For pulse processes load figures are reduced by 35 %.

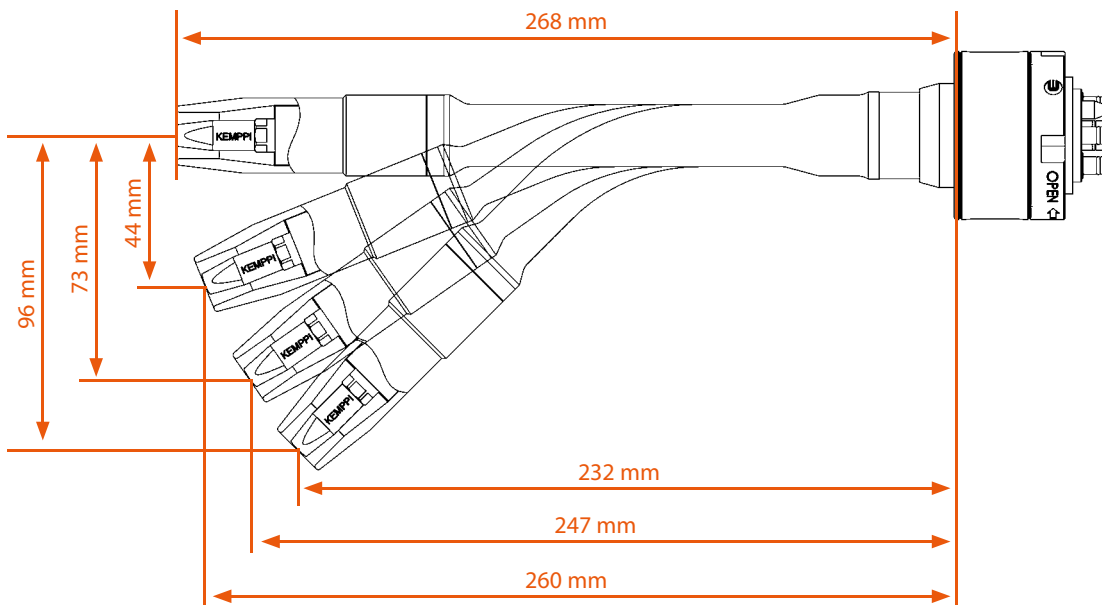



## 25 WELDING GUN NECKS FOR WATER COOLED SYSTEMS



Ordering code	Description	Additional info
SP600550	GUN NECK 500-W 0°	
SP600551	GUN NECK MIG 500-W 22°	Recommended as default
SP600552	GUN NECK 500-W 35°	
SP600553	GUN NECK MIG 500-W 45°	
Consumables		
SP600561	INSULATING RING 500-W	Default for water cooled necks. One included in gun neck delivery.
SP600562	INSULATING RING, HIGH TEMPERATURE 500-W	
SP600563	GAS DIFFUSER 500-W	Replacing insulation ring in aluminium welding applications

### TECHNICAL SPECIFICATIONS

Loadability	100%ED 500 A / CO <sub>2</sub> , 100%ED 500 A / M <sup>21</sup>
Filler wires	0.8...1.6 mm
Gas flow	min. 25 l / min
Water flow	min. 1.25 l / min
Weight	0.9 kg

EN 60974-7. For pulse processes load figures are reduced by 35 %.

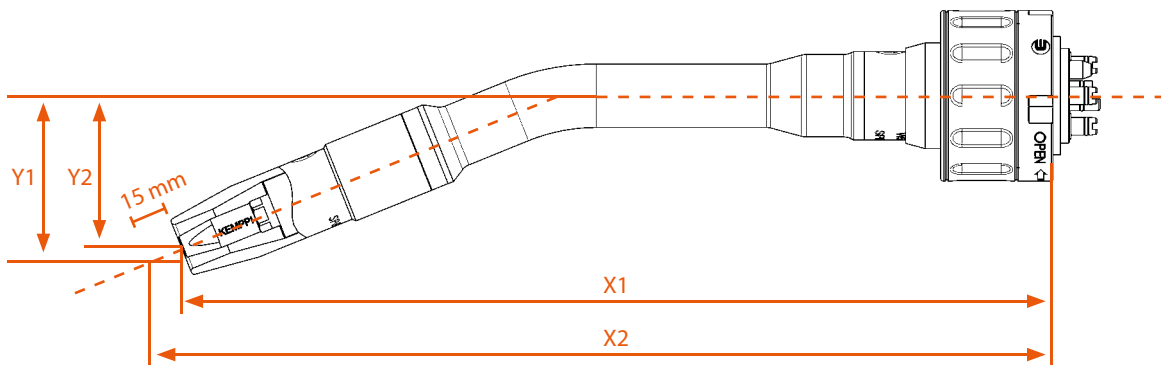

Ordering code		X1 mm	X2 mm	Y1 mm	Y2 mm
SP600550	0°	236	251		
SP600551	22°	228	242	44	50
SP600552	35°	215	227	73	81
SP600553	45°	200	211	94	105



## 26 CONICAL GAS NOZZLES FOR GAS COOLED GUN NECKS

Screw-on type connection to neck. Massive design for long life and heat transfer purposes. Good insulation properties separating front end of the gas nozzle from cable connection – against heat and electricity.



Ordering code	Description	Additional info
SP600645	GAS NOZZLE CONICAL 500-G 16/+3	
SP600646	GAS NOZZLE CONICAL 500-G 16/-2	
SP600627	GAS NOZZLE CONICAL 500-G 16/0	Recommended as default

### Three lengths to choose from (TCP remains the same)



-2 mm, best gas flow, gas nozzle most sensitive against spatter

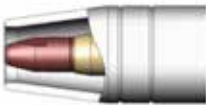

0 mm, recommended as default



+3 mm, best accessibility, gas nozzle less sensitive against spatter generation, gas shielding reduced



Ordering code	Description	Additional info
SP600663	GAS NOZZLE SENSOR CLIP 500-G	Needed if seam searching uses gas nozzle as the sensing tool





## 27 BOTTLE SHAPED GAS NOZZLES FOR GAS COOLED GUN NECKS

For optimized accessibility screw-on type connection to neck. Massive design for long life and heat transfer purposes. Good insulation properties separating front end of the gas nozzle from cable connection – against heat and electricity.



Ordering code	Description	Additional info
SP600643	GAS NOZZLE, BOTTLE FORM 500-G 16/0	
SP600644	GAS NOZZLE BOTTLE FORM 500-G 16/-2	
SP600626	GAS NOZZLE 500-G BOTTLE FORM 16/+3	

Three lengths to choose from (TCP remains the same)



-2 mm, best gas flow, gas nozzle most sensitive against spatter



0 mm, recommended as default



+3 mm, best accessibility, gas nozzle less sensitive against spatter generation, gas shielding reduced



Ordering code	Description	Additional info
SP600663	GAS NOZZLE SENSOR CLIP 500-G	Needed if seam searching uses gas nozzle as the sensing tool



## 28 CONICAL GAS NOZZLES FOR WATER COOLED GUN NECKS

Screw-on type connection to neck. Designed for long life and heat transfer purposes.



Ordering code	Description	Additional info
SP600557	GAS NOZZLE CONICAL 500-W 16/+3	
SP600558	GAS NOZZLE CONICAL 500-W 16/0	recommended as default
SP600559	GAS NOZZLE CONICAL 500-W 16/-2	

### Three lengths to choose from (TCP remains the same)



-2 mm, best gas flow, gas nozzle most sensitive against spatter



0 mm, recommended as default



+3 mm, best accessibility, gas nozzle less sensitive against spatter generation, gas shielding reduced



## 29 BOTTLE SHAPED GAS NOZZLES FOR WATER COOLED GUN NECKS

Screw-on type connection to neck. Designed for long life and heat transfer purposes.



Ordering code	Description	Additional info
SP600554	GAS NOZZLE BOTTLE FORM 500-W 16/+3	
SP600555	GAS NOZZLE BOTTLE FORM 500-W 16/0	
SP600556	GAS NOZZLE BOTTLE FORM 500-W 16/-2	

Three lengths to choose from (TCP remains the same)



-2 mm, best gas flow, gas nozzle most sensitive against spatter

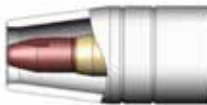

0 mm, recommended as default



+3 mm, best accessibility, gas nozzle less sensitive against spatter generation, gas shielding reduced

## 30 CONTACT TIPS

Kemppi LiFE+ contact tips last up to 5 times longer than standard copper tips, due to innovative alloying and hardening techniques. The LiFE+ core element retains its hardness and refined micro structure, even after elevated welding temperatures of 1000°C.



Ordering code	Description	Additional info
W007919	CONTACT TIP 0.8/D10 M8 / LIFE+	
W007920	CONTACT TIP 0.9/D10 M8 / LIFE+	
W006826	CONTACT TIP 1.0/D10 M8 / LIFE+	
W006518	CONTACT TIP 1.2/D10 M8 LIFE+	
W010309	CONTACT TIP 1.4/D10 M8 / LIFE+	
W007921	CONTACT TIP 1.6/D10 M8 / LIFE+	



## ACCESSORIES FOR WATER COOLED NECKS

### WRENCH - TOOL FOR 500-W NECK



Ordering code SP600569

Pin wrench to unscrew the gun connection easily

### ALIGNMENT TOOL FOR GUN NECK INNER TUBE



Ordering code SP600568

Alignment tool to align Contact Tip with Gas Nozzle

### ALIGNMENT JIG FOR 500-W NECK



Ordering code SP600565

Alignment jig for water cooled necks

### THREAD CUTTER TOOL FOR GUN NECK INNER TUBE



SP600707

THREAD CUTTER TOOL  
FOR GUN NECK 500-W

Thread cleaning/cutter tool for gun neck inner tube

### TEACHING TIP



SP600567

TEACHING TIP M8 STICKOUT 17 MM / SP600566 also available Teaching TIP M8  
Stickout 15 MM



## ACCESSORIES FOR GAS COOLED NECKS

### ALIGNMENT TOOL FOR GUN NECK INNER TUBE



Ordering code SP600568 Alignment tool to align Contact Tip with Gas Nozzle

### ALIGNMENT JIG FOR 500-G NECK



SP600632 ALIGNMENT JIG 500-G Alignment jig for gas cooled necks

### THREAD CUTTER TOOL FOR GUN NECK INNER TUBE



SP600662 THREAD CUTTER TOOL FOR GUN NECK 500-G Thread cleaning/cutter tool for gun neck inner tube

### TEACHING TIP



SP600567 TEACHING TIP M8 STICKOUT 17 MM



# ROBOTIC GUN CLEANING STATION



Reduce downtime - less manual maintenance work required. Contributes significantly to weld quality and welding performance of a robot.

Regular mechanical cleaning of the internal surfaces of the gas nozzle provides steady and good shielding gas flow for welding. Helps to avoid spatter to form electrical connection bridges between contact tip and the gas nozzle.

Wire cutting provides accurate stick-out length for search functions. Sharp wire end for better arc ignition.

Provides anti-spatter oil on outer surfaces of gas nozzle to support longer life time.

Delivered with reamer tool and centering V-block (prism) for both gas and water cooled Kemppi Guns.

No liquids included, must be ordered separately

Ordering code	Description	Additional info
SP600674	ROBOT GUN CLEANING STATION	Equipped with wire cutter, gas nozzle inside reamer and anti-spatter spray unit; order code includes reamer setup for both gas and water cooled nozzles.

## TECHNICAL SPECIFICATIONS

Pneumatic equipment	
Nominal pressure	6 bar 88 psi
Nominal flow	Approx. 500 l/min
operating pressure	6 – 8 bar / 88 - 116 psi
Nominal rotational speed	800 rpm
Max. Wire size	1.6mm (by 6 bar 7 88 psi air pressure)
Weight	22 kg
Ambient temperature	+5° to +50°C
Protection	IP 21

Electrical equipment	
5/2 way valves	
Rated voltage	24 V DC
Power consumption	4.5 W (EACU)

Inductive proximity switch, normally-open contact, (pnp)	
Operating voltage	10 to 30 V DC
Permitted residual ripple	V <sub>pp</sub> < 10%
Continuous current	Max. 200 mA
Current consumption	approx. 4 mA (24 V)
Voltage drop	approx 1.2 V (200 mA)



## CONSUMABLES FOR ROBOTIC GUN CLEANING STATION



Ordering code	Description	Additional info
SP600681	Reamer tool	for water cooled gun
SP600682	Reamer tool	for gas cooled gun



Ordering code	Description	Additional info
SP600683	Prism	for outer Ø 25mm nozzles water cooled gun
SP600684	Prism	for outer Ø 28mm nozzles gas cooled gun

### ANTI-SPATTER SPRAY LIQUID - RECOMMENDATION

The anti-spatter spray unit can be used with high quality liquid designed specifically for protecting gas nozzle, contact tip and rest of the front end of the welding gun in welding environment. An example of Kemppi approved suitable liquid type is ABI-Mist Anti-Spatter liquid from Abicor Binzel. Note also local environmental laws and restrictions when selecting the liquid.



# A7 MIG WELDER EXAMPLE SETUP 1

Gas cooled set for a hollow wrist robot

## POWER SOURCE

	Code	Qty	Notes
A7 MIG POWER SOURCE 350	6201350	1	
ANYBUS-CC M30 DEVICENET M12	9774121DEV12	1	
STAND FOR A7 MIG WELDER	6185295	1	

## WIRE FEEDER

A7 MIG WIRE FEEDER 25-LH-EUR	6203510	1	EA
FE (MC/FC) V1.0 HD GT04 T KIT #3	F000373	1	pcs
BRACKET: A7 WF BRACKET KAWASAKI BA006N	SP800717	1	pcs
WIRE CONDUIT-1.8M ROBOT KEMPPI	SP600535	1	pcs
SNAP CONNECTOR MARATHONPACK	W005189	1	pcs
SNAP CONNECTOR MARATHONPACK	W005189	1	
SNAP CONNECTOR MALE MARATHONPACK	W005197	2	
WIRE SPOOL SUPPORT RIGHT	W007628	1	pcs
WIRE SPOOLPROTECTION	SP007940	1	pcs
FLOOR ASSEMBLY WIRE BOBBIN	W007356	1	pcs

## CABLES

INTERCONNECTION CABLE: A7 ROBOT 70-5-GH	6260483	1	EA
INTERCONNECTION CABLE CLAMPS: CABLE BRACKET SET REIKU 52	SP800888	1	pcs
EARTH RETURN CABLE 70 MM <sup>2</sup> 5M	6184711	1	pcs

## WELDING GUN PACKAGE

GUN NECK 500-G 22°	6260482	1	pcs
CONTACT TIP ADAPTER: CONTACT TIP ADAPTER M8 500-G	SP600629	1	pck5
CONTACT TIP 1.0/D10 M8 / LIFE+	W006826	1	pck50
GAS NOZZLE CONICAL 500-G 16	SP600627	1	pck10
ROBOT GUN MOUNT T1 G	SP600589	1	pcs
CABLE ALIGNMENT TOOL FOR GUN MOUNT T1	SP600602	1	pcs
FLANGE FOR ROBOT 6TH AXIS: FLANGE T1 KAWASAKI BA006N	SP600695	1	pcs
CABLE ASSEMBLY T1 G KAWASAKI BA006N EURO	SP600698	1	pcs
LINER STEEL 1.6/4.6 2M ROBOT EU	SP600725	1	pcs

## CLEANING STATION

ROBOT GUN CLEANING STATION	SP600674	1	pcs
----------------------------	----------	---	-----

## WELDING SOFTWARE

WiseThin-A	9990419	1	pcs
F03 WiseThin+ Fe	99904317	1	pcs

Consult Kemppi sales for available pre-set curves WiseThin-A





## A7 MIG WELDER EXAMPLE SETUP 2

Water cooled set for a non-hollow wrist robot

### POWER SOURCE

	Code	Qty	Notes
A7 MIG POWER SOURCE 450	6201450	1	
ANYBUS-CC M30 ETHERCAT 2-PORT	9774121ETC12	1	
STAND FOR A7 MIG WELDER	6185295	1	

### COOLING UNIT

A7 COOLER	6068220	1	
-----------	---------	---	--

### WIRE FEEDER

A7 MIG WIRE FEEDER 25-LH-EUR	6203510	1	EA
FE (MC/FC) V1.2 HD GT04 T KIT #3	F000374	1	pcs
BRACKET: A7/DT400 BRACKET KUKA KR10 R1420	SP800810	1	pcs
WIRE CONDUIT-1.8M ROBOT KEMPPI	SP600535	1	pcs
SNAP CONNECTOR MARATHONPACK	W005189	1	pcs
LINER MARATHONPACK (MAX 27 M)	W005195	1	m
SNAP CONNECTOR MARATHONPACK	W005189	1	
SNAP CONNECTOR MALE MARATHONPACK	W005197	2	

### CABLES

INTERCONNECTION CABLE: A7 ROBOT 70-5-WH	6260482	1	EA Corrugated sleeve
INTERCONNECTION CABLE CLAMPS: CABLE BRACKET SET REIKU 52	SP800888	1	pcs
EARTH RETURN CABLE 70 MM <sup>2</sup> 5M	6184711	1	pcs

### WELDING GUN PACKAGE

GUN NECK MIG 500-W 22°	SP600551	1	pcs
CONTACT TIP ADAPTER M8 500-W	SP600560	1	pck5
CONTACT TIP 1.2/D10 M8 LIFE+	W006518	1	pck50
GAS NOZZLE CONICAL 500-W 16/0	SP600558	1	pck10
ROBOT GUN MOUNT T2 L	SP600605	1	pcs
SEGMENT HOLDER FOR GUN MOUNT T2	SP600608	1	pcs
FLANGE FOR ROBOT 6TH AXIS: FLANGE T2 ISO 9409-1A31.5	SP600633	1	pcs
CABLE ASSEMBLY T2 W EURO 0.90M	SP600711	1	pcs
LINER STEEL 1.6/4.6 2M ROBOT EU	SP600725	1	pcs

### CLEANING STATION

ROBOT GUN CLEANING STATION	SP600674	1	pcs
----------------------------	----------	---	-----

### WELDING SOFTWARE

WiseFusion-A	9991014	1	pcs
F14 PMIG Fe	99904150	1	pcs

Consult Kemppi sales for available pre-set curves



# KEMPARC PULSE EXAMPLE SETUP 1

Water cooled set for a hollow wrist robot

## POWER SOURCE SETUP

	Code	Qty	Notes
KEMPARC PULSE 450 POWER SOURCE	6200450	1	
FIELD BUS INTERFACE ETHERCAT	9774120ETC	1	

## WATER COOLING UNIT

KEMPCOOL 10 COOLING UNIT	6208100	1	
--------------------------	---------	---	--

## WIRE FEEDER SETUP

KEMPARC DT400 WIRE FEEDER	6203400	1	
FE (MC/FC) V1.2 HD DURATORQUE KIT #3	F000352	1	Consumable item
BRACKET KUKA KR8 R1820 HW - DT400	SP800872	1	Robot brand and model specific
SNAP CONNECTOR MARATHONPACK	W005189	1	
LINER MARATHONPACK (MAX 27 M)	W005195	10	
SNAP CONNECTOR MALE MARATHONPACK	W005197	2	

## CABLE SET

ROBOT 70-5-WH DIX	6260478	1	
CABLE BRAKECT KIT	SP800755	1	
EARTH RETURN CABLE 70 MM <sup>2</sup> 5M	6184711	1	

## WELDING GUN SETUP

GUN NECK MIG 500-W 22°	SP600551	1	
CONTACT TIP ADAPTER M8 500-W	SP600560	1	Consumable item
CONTACT TIP 1.2/D10 M8 LIFE+	W006518	1	Consumable item
GAS NOZZLE CONICAL 500-W 16/0	SP600558	1	Consumable item
ROBOT GUN MOUNT T1 W	SP600588	1	
FLANGE T1	SP600582	1	Robot brand and model specific
CABLE ASSEMBLY T1 W KUKA KR8 1620 EURO	SP600702	1	Robot brand and model specific
LINER STEEL HP 2.0/4.7 2.5M ROBOT EU	SP600xxx	1	Consumable item
ROBOT GUN CLEANING STATION	SP600674	1	

## WELDING SOFTWARE

WiseFusion-A	9991015	1	
F104 PMIG Fe	99904427	1	Consult Kemppi sales for available pre-set curves



## KEMPARC PULSE EXAMPLE SETUP 2

Gas cooled set for a non-hollow wrist robot

### POWER SOURCE SETUP

	Code	Qty	Notes
KEMPARC PULSE 350 POWER SOURCE	6200350	1	
FIELD BUS ADAPTER DEVICENET	9774120DEV	1	

### WIRE FEEDER SETUP

KEMPARC DT400 WIRE FEEDER	6203400	1	
FE (MC/FC) V1.0 HD DURATORQUE KIT #3	F000351	1	Consumable item
ABB IRB 1600 SUPPORT DT 400	W004137	1	Robot brand and model specific
WIRE SPOOL SUPPORT RIGHT	W007628	1	
WIRE SPOOL PROTECTION	SP007940	1	
FLOOR ASSEMBLY WIRE BOBBIN	W007356	1	
WIRE CONDUIT-1.8M ROBOT KEMPPPI	SP600535	1	Consumable item
SNAP CONNECTOR MARATHONPACK	W005189	1	

### CABLE SET

ROBOT 70-5-GH DIX	6260446	1	
cable brackect set Reiku 52	SP800888	2	
EARTH RETURN CABLE 70 MM <sup>2</sup> 5M	6184711	1	

### WELDING GUN SETUP

GUN NECK 500-G 22°	SP600622	1	
CONTACT TIP ADAPTER M8 500-G	SP600629	1	Consumable item
CONTACT TIP 1.0/D10 M8 / LIFE+	W006826	1	Consumable item
GAS NOZZLE CONICAL 500-G 16/0	SP600627	1	Consumable item
ROBOT GUN MOUNT T2 L	SP600605	1	
SEGMENT HOLDER FOR GUN MOUNT T2	SP600608	1	
FLANGE T2 ABB IRB 1600/2400L	SP600639	1	Robot brand and model specific, consult Kemppi Sales
CABLE ASSEMBLY T2 G EURO L=1.10	SP600610	1	Robot model specific
LINER STEEL HP 2.0/4.7 2.5M ROBOT EU	SP600xxx	1	Consumable item
ROBOT GUN CLEANING STATION	SP600674	1	

### WELDING SOFTWARE

F03 1-MIG Fe	99904136	1	Consult Kemppi sales for available pre-set curves
--------------	----------	---	---



# KEMPARC SYNERGIC EXAMPLE SETUP

Water cooled set for a hollow wrist robot

## POWER SOURCE SETUP

	Code	Qty	Notes
KEMPARC SYN 500 POWER SOURCE	6201500	1	
FIELD BUS INTERFACE ETHERCAT	9774120ETC	1	

## WATER COOLING UNIT

KEMPCOOL 10 COOLING UNIT	6208100	1	
--------------------------	---------	---	--

## WIRE FEEDER SETUP

KEMPARC DT400 WIRE FEEDER	6203400	1	
FE (MC/FC) V1.2 HD DURATORQUE KIT #3	F000352	1	Consumable item
BRACKET KUKA KR8 R1820 HW - DT400	SP800872	1	Robot brand and model specific
SNAP CONNECTOR MARATHONPACK	W005189	1	
LINER MARATHONPACK (MAX 27 M)	W005195	10	
SNAP CONNECTOR MALE MARATHONPACK	W005197	2	

## CABLE SET

ROBOT 70-5-WH DIX	6260478	1	
CABLE BRAKECT KIT	SP800755	1	
EARTH RETURN CABLE 70 MM <sup>2</sup> 5M	6184711	1	

## WELDING GUN SETUP

GUN NECK MIG 500-W 22°	SP600551	1	
CONTACT TIP ADAPTER M8 500-W	SP600560	1	Consumable item
CONTACT TIP 1.2/D10 M8 LIFE+	W006518	1	Consumable item
GAS NOZZLE CONICAL 500-W 16/0	SP600558	1	Consumable item
ROBOT GUN MOUNT T1 W	SP600588	1	
FLANGE T1	SP600582	1	Robot brand and model specific
CABLE ASSEMBLY T1 W KUKA KR8 1620 EURO	SP600702	1	Robot brand and model specific
LINER STEEL HP 2.0/4.7 2.5M ROBOT EU	SP600xxx	1	Consumable item
ROBOT GUN CLEANING STATION	SP600674	1	Consumable item



# Contact information

## Kemppt Oy

**Head office, production, distributor and domestic sales**

P.O. Box 13 (Kempinkatu 1)  
15801 LAHTI  
FINLAND  
Tel. +358 3 899 11

## Kemppt Sverige AB

Kung Hans väg 3  
19268 Sollentuna  
SWEDEN  
Tel. +46-8-590 783 00  
e-mail: sales.se@kemppt.com

## Kemppt Norge A/S

Danholmen 19  
3115 Tønsberg  
Postboks 2151, Postterminalen  
3103 Tønsberg  
NORWAY  
Tel. +47 33 34 60 00  
e-mail: sales.no@kemppt.com

## Kemppt A/S

Literbuen 11  
2740 Skovlunde  
DENMARK  
Tel. +45 4494 1677  
e-mail: sales.dk@kemppt.com

## Kemppt Benelux B.V.

Minervum 7284  
4817 ZM Breda  
THE NETHERLANDS  
Tel. +31 76 571 7750  
e-mail: sales.nl@kemppt.com

## Kemppt Benelux B.V.

Belgium  
Tel. +32 15 212 880  
e-mail: sales.nl@kemppt.com

## Kemppt (U.K) Ltd.

Martti Kemppt Building  
Priory Business Park  
Fraser Road  
Bedford, MK443WH  
UNITED KINGDOM  
Tel. +44 845 6444201  
e-mail: sales.uk@kemppt.com

## Kemppt France S.A.S

65 Avenue de la Couronne des Prés  
78681 Épône Cedex  
FRANCE  
Tel. + 33 (0) 1 30 90 04 40  
e-mail: vente.fr@kemppt.com

## Kemppt GmbH

Perchstetten 10  
35428 Langgöns  
GERMANY  
Tel. +49 6403 7792 0  
e-mail: sales.de@kemppt.com

## Kemppt Spółka z o.o.

ul. Kolonijna 3  
03-565 Warszawa  
POLAND  
Tel. +48 22 7815301  
e-mail: info.pl@kemppt.com

## Kemppt Australia Pty Ltd

13 Cullen Place  
Smithfield NSW 2164  
Sydney  
AUSTRALIA  
Tel. +61 2 9605 9500  
e-mail: sales.au@kemppt.com

## Kemppt Russia

Polkovaya str. 1  
Building 6  
127018 Moscow  
RUSSIA  
Tel. +7 495 739 4304  
e-mail: info.ru@kemppt.com

## Kemppt Welding Technology (Beijing) Co., Ltd.

Unit 105, 1/F, Building #1,  
No. 26 Xihuan South Road  
Beijing Economic-Technological Development  
Area (BDA)  
100176 Beijing  
CHINA  
Tel. +86 10 6787 6064  
e-mail: sales.cn@kemppt.com

## Kemppt India Private Limited

Lakshmi Towers  
New No. 2/770, First Main Road  
Kazura Garden, Neelankarai  
Chennai—600 041  
Tamil Nadu  
INDIA  
Tel. +91 7338744500  
e-mail: sales.india@kemppt.com

**Kemppi** is the pioneering company within the welding industry. It is our role to develop solutions that make you win business. Headquartered in Lahti, Finland, Kemppi employs over 800 welding experts in 17 countries and has a revenue of more than 150 MEUR. Our offering includes welding solutions - intelligent equipment, welding management software and expert services - for both demanding industrial applications and ready-to-weld needs. Local expertise is available via our global partner network covering over 60 countries.

[www.kemppi.com](http://www.kemppi.com) |       

