

Welding guns and torches

PRODUCT CATALOGUE



FLEXLITE

Guns and torches for efficient welding

2022-2023





FLEXLITE

Everyday welding comfort

Welding guns and torches must withstand extreme temperatures in a demanding environment, whilst allowing the creation of high quality welds.

Flexlite professional series are designed for reliable welding performance, focused around everyday welding comfort.

Flexlite products feature specific user values, including light weight, balance, and reduced wrist loading. They feature excellent technical performance and extended consumables life.

EASY ACCESS TO INFORMATION

All Flexlite torches are equipped with a QR code to help you find the right parts and accessories. Scan the code, and it takes you directly to relevant ordering codes, consumables, product documents and Kemppi contacts.



Best gun for each task

Kemppi's Flexlite guns for MIG/MAG welding are divided into three series: 3, 5 and 8. Each series is designed to serve specific welding needs. The higher the series, the more features you get.

All series models enjoy the Flexlite features for user comfort and extended consumable part life. Designed with superb balance, they reduce wrist loading and work fatigue. The same consumables can be used in all series models, which simplifies spare part management and makes it more cost-efficient.

Series 8 models are a powerful combination of ergonomic and technical welding performance. The LED work light provides better visibility in low light working conditions, aiding pre-weld positioning and post-weld visibility. The gas-cooled Series 8 gun range features exchangeable swan necks. The Kemppi Gun Connector offers enhanced mechanical and electrical properties together with real-time arc voltage measurement. Series 8 gun range is compatible with X8 MIG Welder.



Series 5 models suit a variety of professional applications and include both gas- and water-cooled models. MN stands for Multi-Neck, a fast-change gun neck system, allowing one of three neck variants to be selected and fitted to the gun handle in seconds. All Series 5 models accept the optional remote control device, which provides real-time selection of welding power or memory channels during welding. Euro connector guarantees connectivity with most MIG/MAG welding equipment brands.



Series 3 models are suitable for use across a wide range of materials and tasks. They are available in both gas- and water-cooled models from 3 to 5 meters in length. Euro connector guarantees connectivity with most MIG/MAG equipment brands. No option for remote control.



The most suitable TIG torch for your needs

Kemppi Flexlite TX torches for TIG welding are divided into two series: 3 and 5. Both series are defined to serve specific welding needs. The higher the series, the more features you get.

Both series models enjoy the Flexlite features for user comfort, welding efficiency and extended consumable parts life. Same consumables can be used in both series models, which makes the inventory management cost-efficient and easy.

Series 5 models are designed to make TIG welding more efficient and provide the best welding ergonomics in all welding positions. Optional on-torch remote control allows accurate welding current adjustment at a distance. You can choose from rocker or roller type of switch. Series 5 models are equipped with snap connectors in water hoses and a 7-pin control cable connector.

Series 3 models improve your welding satisfaction and increase usability. Wide range of models with different capacity, size and length ensure that you will always find the best welding torch for each welding task. Series 3 models have screw-in connectors in water hoses and 4-pin control cable connector. In addition, series 3 includes models with Euro connector and DIX connector. Dix connector models have a shielding gas valve in the torch body.





CONTENTS

FLEXLITE GX GUNS FOR MIG WELDING Gas and water-cooled MIG welding guns

Flexlite GX	8
Flexlite GX features	16
Accessories	18
Flexlite GX models	20
Consumables by gun model	22
Factory-installed consumables	36
Technical data and ordering codes	38

FLEXLITE GC GUNS FOR MIG WELDING Gas-cooled MIG welding guns equipped with coaxial cable

Flexlite GC	40
Flexlite GC models	42
Factory-installed consumables	43
Technical data and ordering codes	43
Consumables by gun model	44

FLEXLITE GF GUNS FOR MIG WELDING Fume extraction guns for MIG welding

Flexlite GF	46
Flexlite GF features	54
Consumables by gun model	56
Factory-installed consumables	60
Technical data and ordering codes	61
Flexlite GF models	61

GENERAL MIG CONSUMABLES

Gas nozzles	62
Contact tips	63
Gun neck compatibility table	65
Wire liners	68
Wire guide tubes	70
MIG consumable kits	71

FLEXLITE TX TORCHES FOR TIG WELDING Gas and water-cooled TIG welding torches

Flexlite TX	74
Flexlite TX features	80
Flexlite TX models	82
Technical data	84
Accessories	88
Consumables	90
Consumable kits	96
Ordering codes	99

FLEXLITE GX

Natural extension to your hand

Flexlite GX product series contains welding guns to be used in MIG/MAG welding processes. There are Flexlite GX models available in three series: 3, 5 and 8. Each series is designed to serve specific welding needs. All Flexlite GX models enjoy the Flexlite features for user comfort, welding efficiency and extended consumable part life.

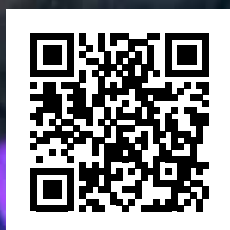

Visit website:

> <https://kemp.cc/flexlite-gx/com-en>



Flexlite GX guns for MIG/MAG welding

Kemppi's Flexlite GX guns for MIG/MAG welding increase user comfort and welding productivity. Their innovative production methods, high quality materials and strict quality control guarantee that you can rely 100 % on your Flexlite GX welding gun.

The pistol grip handle, anatomically designed shape and excellent balance reduce wrist loading, allowing the welder to concentrate on challenging tasks to achieve the perfect weld. This has a good effect on both quality and productivity.

If you calculate the total cost of ownership for a Flexlite GX welding gun, you will see that it stands out for its long-life consumables, for its efficiency and good ergonomics, and that it clearly improves your overall welding productivity.

The Flexlite GX welding guns are available in alternative power classes and lengths, including different neck versions.



EXCELLENT ERGONOMICS

Lower fatigue has a positive effect on welder's work and results in better quality and efficiency.



EFFICIENT WELDING

High-performance torch uses the power source capacity efficiently and helps you create smooth and spatter-free welds.



LONG CONSUMABLE LIFE

Reliable and durable Kemppi consumable parts support welding quality and productivity.



Manual welding is heavy physical work, which requires you to stay very alert for long periods of time. It helps if your tools have special features that reduce work fatigue – and the Flexlite GX welding guns match this description perfectly.

When it comes to usability, you know Flexlite GX makes a great choice!

Flexlite GX welding guns feature impressive shape and balance. Flexible cable sets and ball-jointed cable protection reduce wrist loading, so that you can really feel the difference. This lowers the welder fatigue and leads to increased work quality and efficiency.

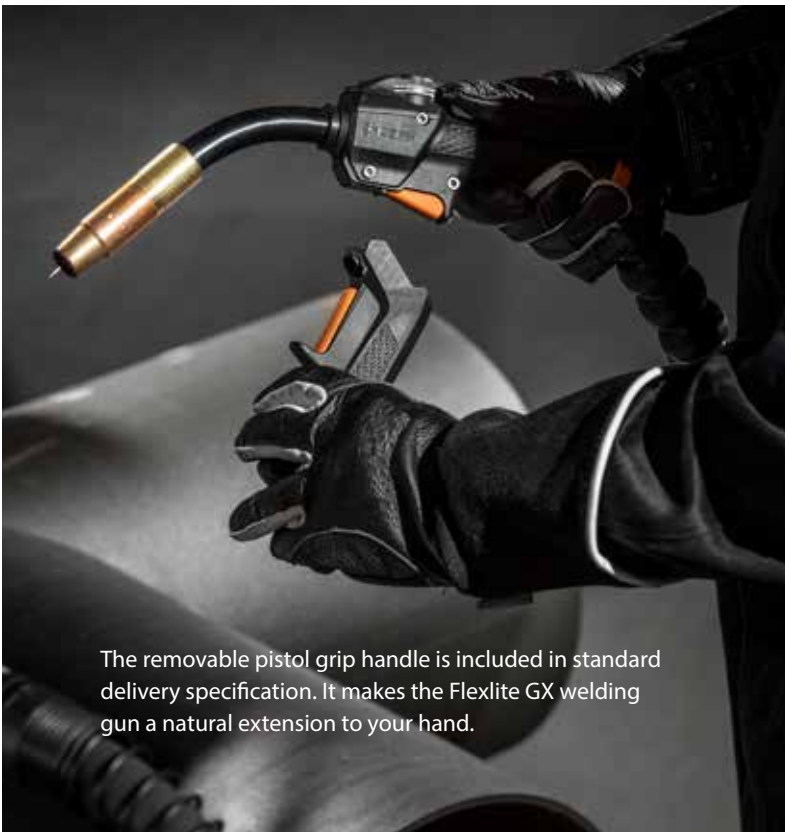

The removable pistol grip handle is included in standard delivery specification. It makes the Flexlite GX welding gun a natural extension to your hand.

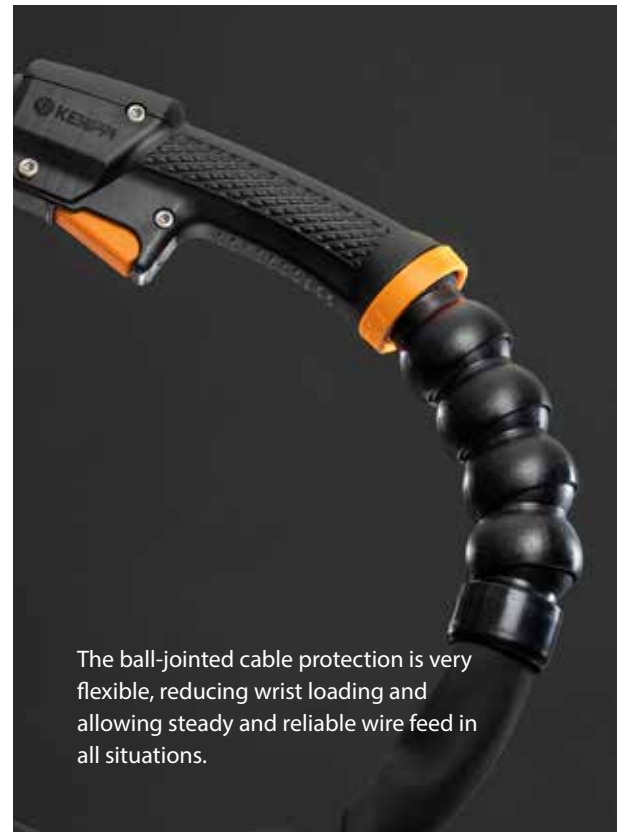

The ball-jointed cable protection is very flexible, reducing wrist loading and allowing steady and reliable wire feed in all situations.

A close-up, high-contrast photograph of a metal weld joint. The weld is characterized by a series of overlapping, rippled ridges that create a textured, almost scale-like appearance. The lighting is dramatic, highlighting the metallic sheen and the intricate details of the weld's structure against a dark, shadowed background.

Every welder has a unique handwriting. It is of great significance, what kind of torch you are holding when filling the seam. Flexlite is the right instrument for every skilled welding professional. It helps you create a handwriting that stands out for its quality.

Innovative design is reflected in weld quality and welding efficiency

Flexlite GX models feature lower gun neck and contact tip temperatures. This has been achieved with a new, innovative gun neck structure, where the cooling channels run closer to the main consumables, and they are separated from the shielding gas channels.

Together with high quality consumable parts, this feature elevates welding efficiency and improves the welding quality. It also extends the lifetime of consumable parts, leading to easier spare part management and savings in consumable costs.

35 % COOLER THAN OTHERS

According to tests made in Kemppi welding laboratory, the Flexlite GX welding guns showed up to **35 % temperature decrease** in contact tip, when compared to a corresponding non-Flexlite welding gun. This indicates that Flexlite's multi-channel cooling system plays an important role in significant lifetime improvement of consumables.



Shielding gas flow has a significant effect on weld quality. Normally shielding gas is invisible, but with Schlieren imaging technology it is possible to observe the real gas flow. This illustrates, how Flexlite GX welding gun design and consumable parts enable laminar gas flow and better shielding gas coverage.

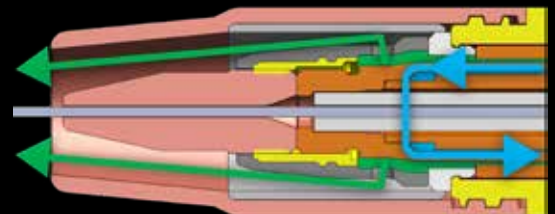

Cooling liquid circulates close to main consumables, keeping them cooler and extending their lifetime. (Blue arrows)

Separate shielding gas channels in the gun neck enable cleaner welds, less spatters and smaller shielding gas consumption. (Green arrows)



Genuine Kemppi spare parts are made of high quality materials and under strict quality control and inspection. The Kemppi brand mark on the spare part is a guarantee of a long and reliable lifetime.

Less consumables means lower inventory costs

Flexlite GX welding guns feature improved thermal efficiency, which enables cooler temperatures and extended consumable lifetime and leads to more than 50 % lower consumables usage. High-performance, precision-drilled contact tips with improved wear life suit wide-ranging applications and filler wire types.

LESS PARTS, LOWER COSTS

The number of changeable parts has been reduced by improving cross-matching across corresponding models, and by combining the functions of some of the consumables. As a result, the total number of consumables has been reduced per individual gun models. This lowers inventory costs and makes Flexlite perfect for workshop cost management.



Original Kemppi contact tips are marked with a Kemppi brand mark. They are precision-drilled, high-performance contact tips that last longer and make the welding gun operation more reliable, bringing you direct cost savings.

For more information on Kemppi contact tips, see page 63.

Easy contact tip size selection for different filler wire materials and applications with three clearance groups: C1, C2 and C3.

Better quality and

GUN REMOTE CONTROL

Optional on-torch remote controls allow accurate and immediate welding current adjustment and memory channel selection at a distance. Available for Series 5 welding guns.

ERGONOMIC HANDLE DESIGN

Anatomically shaped handle with a firm grip. A modular trigger with a few parts and simple wiring. The handle cover, trigger and gun remote control are quick and easy to change.

WORK LIGHTS

Series 8 guns feature LED work lights to aid pre-weld positioning and post-weld visibility.

IMPROVED NECK COOLING

Separate shielding gas channels and the cooling circulation that is running to the end of the gun neck keep the neck cooler and enable cleaner welds, less spatters and longer consumable life.

LESS PARTS, LOWER COSTS

The number of changeable parts has been reduced by improving cross-matching across corresponding models, and by combining the functions of some of the consumables. This lowers inventory costs and makes Flexlite perfect for workshop cost management.

PISTOL GRIP HANDLE

The pistol grip handle is included in standard delivery specification. It allows a natural wrist position, which makes the work easier and more effortless, especially when doing long welds. Quick to install without tools.



improved productivity



SMART CABLE DESIGN

Flexible cable sets and ball-jointed cable protection reduce wrist torque, which makes the work more easier and more effortless. The cable set features replaceable internal cables and hoses.

EASY ACCESS TO INFORMATION

The QR code takes you directly to relevant ordering codes, consumables, product documents and Kemppi contacts.

CABLE SPRING PROTECTION

Strong, spring-protected cable end prevents sudden bends and protects the hoses inside the cable.

CONNECTION

Series 3 and 5 gun models feature a universal Euro connection to the wire feeder, which enables their connectivity with most MIG/MAG welding equipment brands. Series 8 welding gun models have a special Kemppi connector, allowing accurate data collection from the welding arc.

ACCESSORIES



Flexlite GX accessories provide greater comfort and usability to your welding. The on-torch remote controls reduce the need to leave the workplace to adjust parameters, and the pistol grip handle reduces the wrist loading in certain welding jobs. This makes the welder's work easier and more efficient.

Improve the ergonomics and usability with Flexlite accessories



















Pistol grip handle is a standard accessory included in all Flexlite GX welding gun packages. It allows a natural wrist position, which makes the work easier and more effortless, especially when doing long welds. Quick to install and remove without tools.



GXR10 Gun Remote is an on-torch remote control device for Series 5 Flexlite GX welding guns. When used with a compatible welding system, it allows accurate and immediate welding current adjustment and memory channel selection conveniently from the welding gun.

Fast and easy to install, GXR10 Gun Remote can be purchased as an optional accessory for any Series 5 Flexlite GX welding gun.

Flexlite GX models (Gas)

SERIES 3	page	SERIES 5	page	SERIES 8	page
Flexlite GX 253G Load capacity: 250A/35% Cooling: gas Length: 3.5 m / 5 m	 22	Flexlite GX 255G Load capacity: 250A/35% Cooling: gas Length: 3.5 m / 5 m	 22	Flexlite GX 208G Neck: Multi-neck Load capacity: 200A/60% Cooling: gas Length: 3.5 m / 5 m	 28
Flexlite GX 203G Load capacity: 200A/35% Cooling: gas Length: 3.5 m / 5 m	 23	Flexlite GX 205G Load capacity: 200A/35% Cooling: gas Length: 3.5 m / 5 m	 23	Flexlite GX 308G Neck: Multi-neck Load capacity: 300A/60% Cooling: gas Length: 3.5 m / 5 m	 28
Flexlite GX 303G Load capacity: 300A/35% Cooling: gas Length: 3.5 m / 5 m	 24	Flexlite GX 305G Load capacity: 300A/35% Cooling: gas Length: 3.5 m / 5 m / 6 m / 8 m	 24	Flexlite GX 408G Neck: Multi-neck Load capacity: 400A/60% Cooling: gas Length: 3.5 m / 5 m	 29
Flexlite GX 303GHD Load capacity: 300A/35% Cooling: gas Length: 3.5 m / 5 m	 34	Flexlite GX 305GHD Load capacity: 300A/35% Cooling: gas Length: 3.5 m / 5 m	 34		
Flexlite GX 403G Load capacity: 400A/35% Cooling: gas Length: 3.5 m / 5 m	 25	Flexlite GX 305GMN Neck: Multi-neck Load capacity: 350A/35% Cooling: gas Length: 3.5 m / 5 m	 27		
Flexlite GX 403GHD Load capacity: 400A/35% Cooling: gas Length: 3.5 m / 5 m	 35	Flexlite GX 405G Load capacity: 400A/35% Cooling: gas Length: 3.5 m / 5 m	 25		
		Flexlite GX 405GHD Load capacity: 400A/35% Cooling: gas Length: 3.5 m / 5 m	 35		

* Load capacity 300A/100%

** Load capacity 250A/100%

Flexlite GX models (Water)

SERIES 3	page	SERIES 5	page	SERIES 8	page
Flexlite GX 303W Load capacity: 300A/100% Cooling: water Length: 3.5 m / 5 m	23	Flexlite GX 305W Load capacity: 300A/100% Cooling: water Length: 3.5 m / 5 m / 6 m**	23	Flexlite GX 428W Neck: normal or N250 Load capacity: 420A/100% Cooling: water Length: 3.5 m / 5 m / 8 m*	30, 33
Flexlite GX 403W Load capacity: 400A/100% Cooling: water Length: 3.5 m / 5 m	24	Flexlite GX 405W Load capacity: 400A/100% Cooling: water Length: 3.5 m / 5 m / 6 m* / 8 m*	24	Flexlite GX 528W Neck: normal or N250 Load capacity: 520A/100% Cooling: water Length: 3.5 m / 5 m	31
Flexlite GX 503W Load capacity: 500A/100% Cooling: water Length: 3.5 m / 5 m	25	Flexlite GX 505W Load capacity: 500A/100% Cooling: water Length: 3.5 m / 5 m	25	Flexlite GX 608W Load capacity: 600A/40% Cooling: water Length: 5 m	32
		Flexlite GX 605W Load capacity: 600A/40% Cooling: water Length: 5 m	26		

* Load capacity 300A/100%
 ** Load capacity 250A/100%

The name of a Flexlite welding gun tells its properties and use

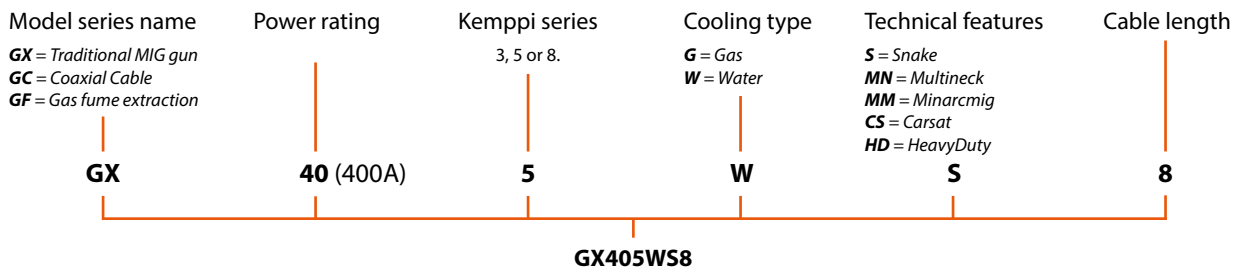

Consumables

 GX253G35, GX253G5, GX255G35, GX255G5

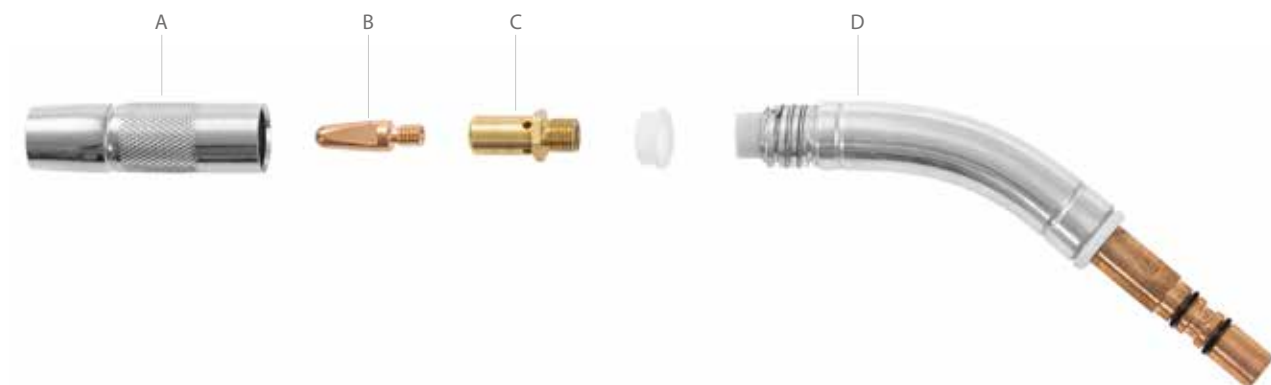

A. Gas nozzle	Ø 18, (20)
958010101	Gas nozzle with insulating bush



D. Gun neck	
SP014695	180G



B. Contact tip	
CT10C1SD003	1.0 C1 STD M6



Wire liners	
W013628	0,9-1,2 FE / 3,5M Ø 5,3/1,8 RD STEEL
W013632	0,9-1,2 FE / 5M Ø 5,3/1,8 RD STEEL





C. Contact tip adapter	
9580173	Contact tip adapter M6



Wire guide tube	
SP022778	Long nut euro 1-piece small

Consumables

 GX203G35, GX203G5, GX205G35, GX205G5

 GX303W35, GX303W5, GX305W35, GX305W5, GX305WS6*

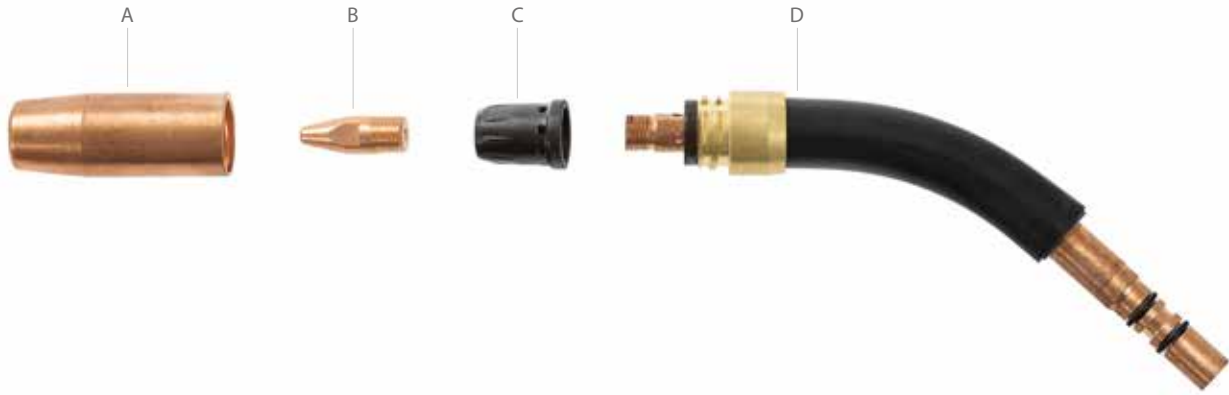

A. Gas nozzle	
W014452	Ø 22 Thread, L57 / OD22 / D14

D. Gun neck	
SP014682	200G
SP014957	300W



B. Contact tip	
CT10C1SD001	1.0 C1 STD M10



Wire liners	
W013628	0,9-1,2 FE / 3,5M Ø 5,3/1,8 RD STEEL
W013632	0,9-1,2 FE / 5M Ø 5,3/1,8 RD STEEL
W016311	1,0-1,2 SS, (FE) / 6,0M Ø 5,9/2,0 CHILI



C. Contact tip adapter	
W013203	M10, insulated



Wire guide tube	
SP022778	Long nut euro 1-piece small
SP022872	Long nut euro 1-piece large

* Model delivered without a wire liner. For ordering codes, see page 68.

Consumables

 GX303G35, GX303G5, GX305G35, GX305G5, GX305GS6*, GX305GS8*

 GX403W35, GX403W5, GX405W35, GX405W5, GX405WS6*, GX405WS8*

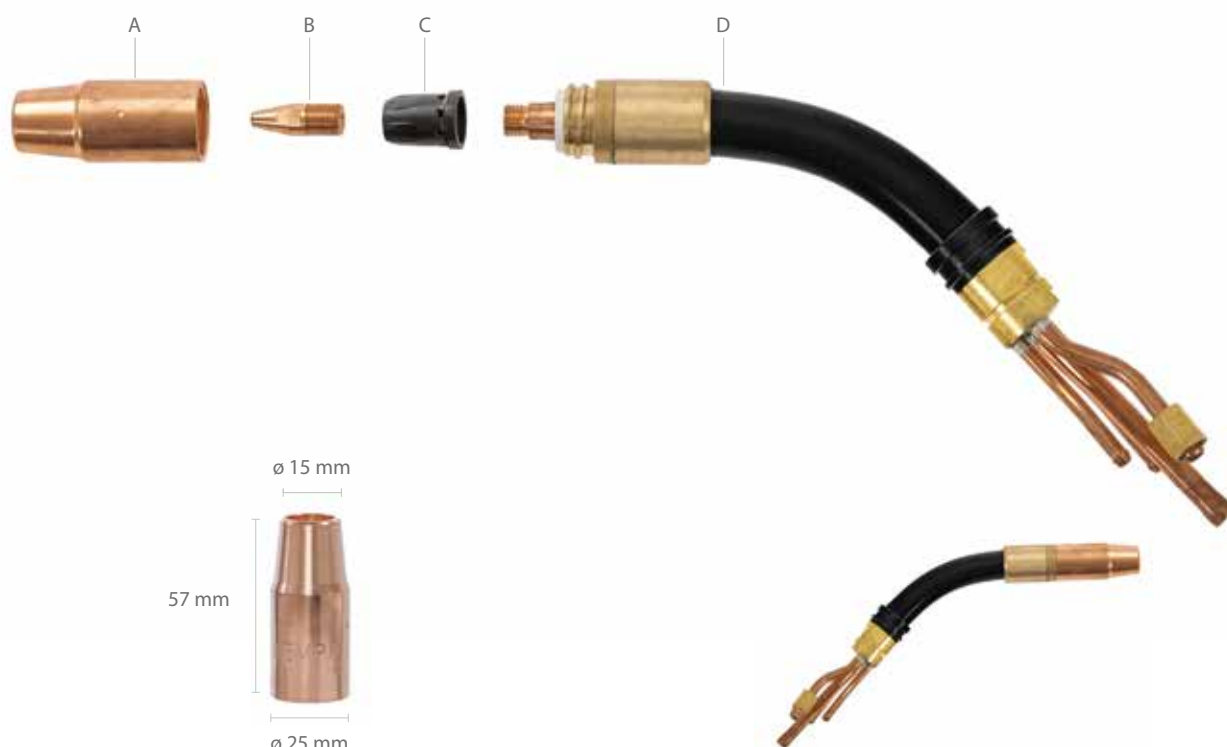

A. Gas nozzle	Ø 25
W011478	Thread, L57 / OD25 / D15

D. Gun neck	
SP013786	300G
SP012594	420W
SP013770	420W, L=250



B. Contact tip	
CT10C1SD001	1.0 C1 STD M10
CT12C1SD001	1.2 C1 STD M10



Wire liners	
W013628	0,9-1,2 FE / 3,5M Ø 5,3/1,8 RD STEEL
W013632	0,9-1,2 FE / 5M Ø 5,3/1,8 RD STEEL
W016311	1,0-1,2 SS, (FE) / 6,0M Ø 5,9/2,0 CHILI
W016312	1,0-1,2 SS, (FE) / 8,0M Ø 5,9/2,0 CHILI



C. Contact tip adapter	
W013203	M10, insulated
W011483	M10



Wire guide tube	
SP022778	Long nut euro 1-piece small

* Model delivered without a wire liner. For ordering codes, see page 68.

Consumables

 GX403G35, GX403G5, GX405G35, GX405G5

 GX503W35, GX503W5, GX505W35, GX505W5

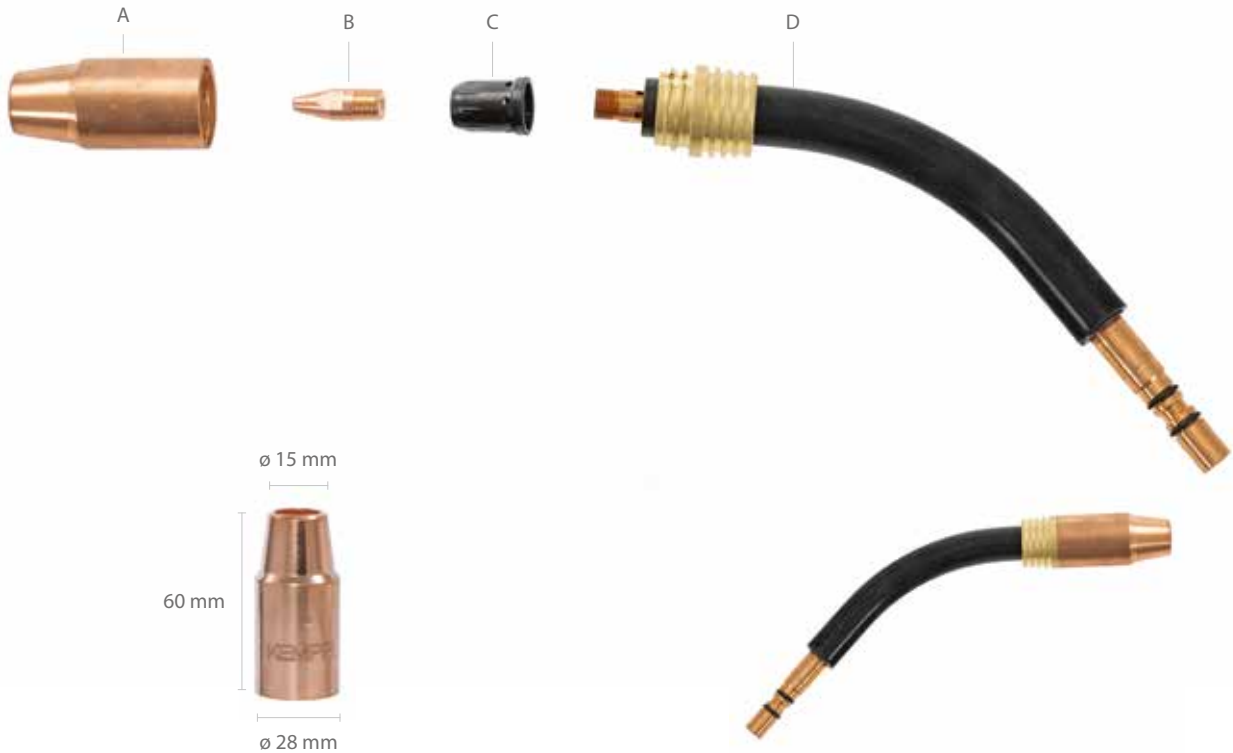

A. Gas nozzle	
W011472	Ø 28 Thread, L60 / OD28 / D15

D. Gun neck	
SP014666	400G
SP012561	520W
SP013778	520W, L=250



B. Contact tip	
CT12C1SD001	1.2 C1 STD M10



Wire liners	
W013628	0,9-1,2 FE / 3,5M Ø 5,3/1,8 RD STEEL
W013632	0,9-1,2 FE / 5M Ø 5,3/1,8 RD STEEL



C. Contact tip adapter	
W013203	M10, insulated
W011483	M10



Wire guide tube	
SP022778	Long nut euro 1-piece small

Consumables

 GX605W5

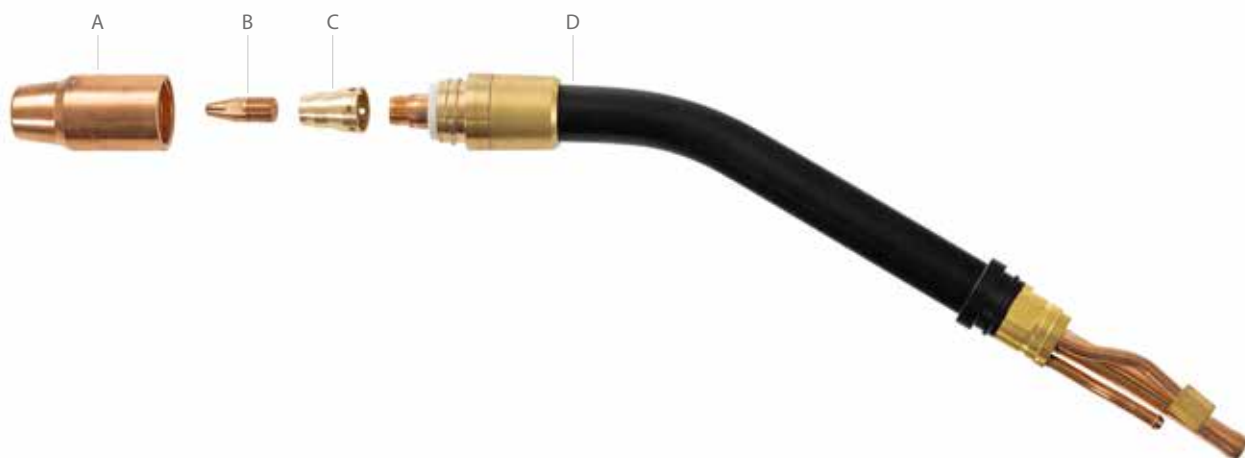

A. Gas nozzle	Ø 30
W012793	Thread, L64 / OD30 / D17

D. Gun neck	
SP012776	600W



B. Contact tip	
CT12C1SD001	1.2 C1 STD M10



Wire liners	
W012614	1,2-1,6 FE / 5,0 M Ø 5,8/2,4 YE STEEL



C. Contact tip adapter	
W012810	M10, 600W



Wire guide tube	
SP022872	Long nut euro 1-piece large

Consumables

 GX305GMN35, GX305GMN5

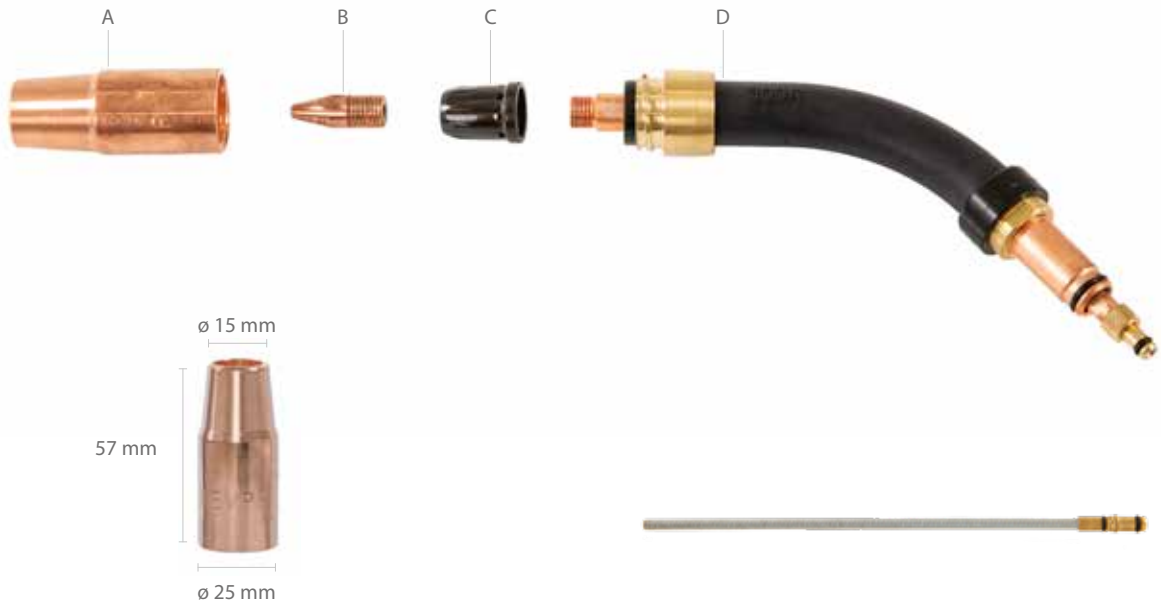

A. Gas nozzle	
W011478	Ø 25 Thread, L57 / OD25 / D15

Neck wire liner	
SP012201	NECK LINER MN 300G 1.5/4.0 L191
SP012202	NECK LINER MN 300G 2.0/4.0 L191
SP012200	NECK LINER MN 300G 2.5/4.0 L191



B. Contact tip	
CT10C1SD001	1.0 C1 STD M10



C. Contact tip adapter	
W013203	M10, insulated
W011483	M10



Wire liners		
W012361	MN 0,9-1,2 FE / 3,5 M	5,6/1,8 RD STEEL
W012363	MN 1,2-1,6 FE / 3,5 M	5,8/2,4 YE STEEL



D. Gun neck	
SP012416	300G MN



Wire guide tube	
SP022872	Long nut euro 1-piece large

Consumables

 GX208GMN35, GX208GMN5, GX308GMN35, GX308GMN5

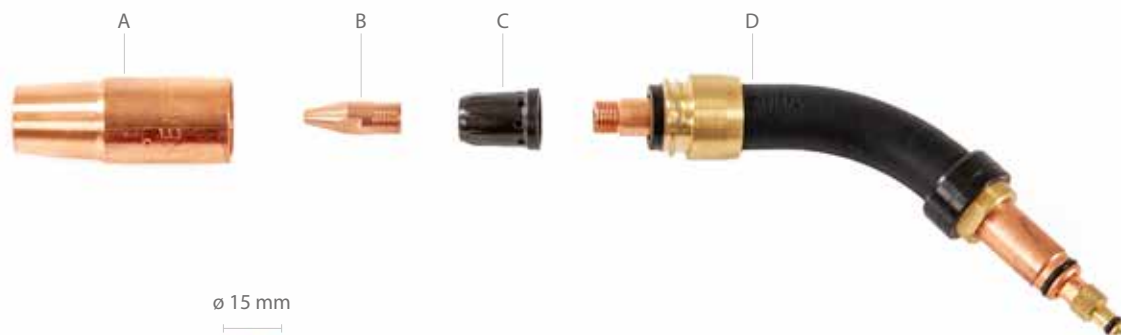

A. Gas nozzle	Ø 25
W011478	Thread, L57 / OD25 / D15



B. Contact tip	
CT10C1SD001	1.0 C1 STD M10



C. Contact tip adapter	
W013203	M10, insulated
W011483	M10 brass



D. Gun neck	
SP012415	200G MN
SP012416	300G MN



Neck wire liner	
SP012238	MN 200G 1.5/4.0 L171
SP012239	MN 200G 2.0/4.0 L171
SP012240	MN 200G 2.5/4.0 L171
SP012201	MN 300G 1.5/4.0 L191
SP012202	MN 300G 2.0/4.0 L191
SP012200	MN 300G 2.5/4.0 L191



Wire liners	
W012361	MN 0,9-1,2 FE / 3,5 M Ø 5,6/1,8 RD STEEL
W012363	MN 1,2-1,6 FE / 3,5 M Ø 5,8/2,4 YE STEEL



Wire guide tube	
SP011868	Guide tube out 1.0 RD plastic

Consumables

 GX408GMN35, GX408GMN5

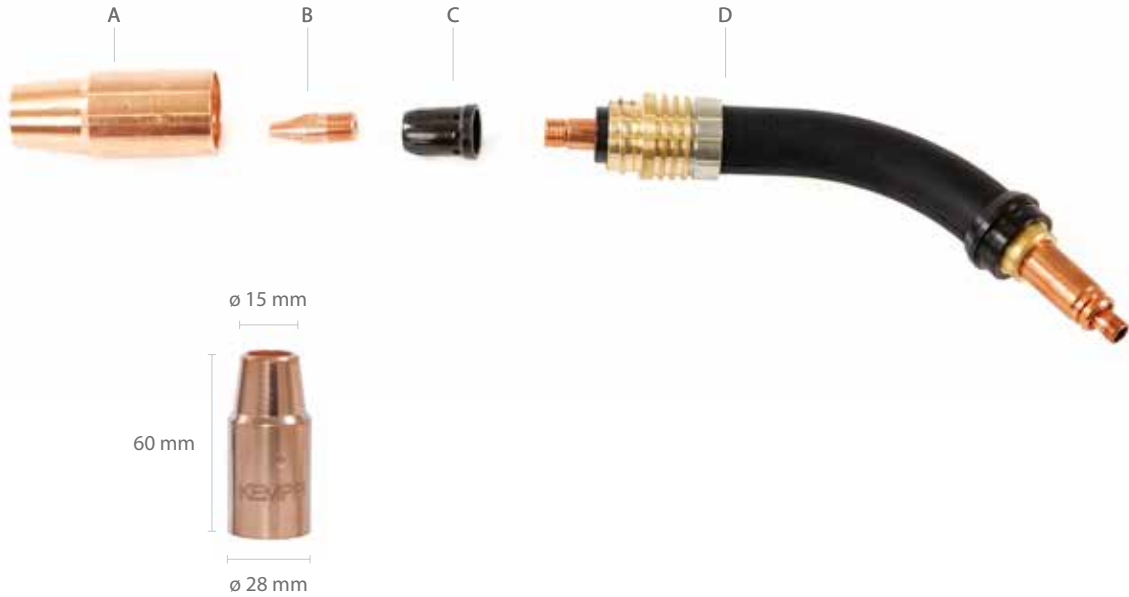

A. Gas nozzle	
W011472	Ø 28 Thread, L60 / OD28 / D15



B. Contact tip	
CT12C1SD001	1.2 C1 STD M10



C. Contact tip adapter	
W013203	M10, insulated
W011483	M10



D. Gun neck	
SP012417	400G MN
SP021845	400 G STRAIGHT, GX
SP021121	300G MN STRAIGHT L=200 MM
SP017001	300G MN STRAIGHT L=600 MM
SP022074	300 G MN FLEX, GX



Neck wire liner	
SP012235	MN 400G 1.5/4.0 L216
SP012236	MN 400G 2.0/4.0 L216
SP012237	MN 400G 2.5/4.0 L216
SP021124	MN 300G 2.0/4.0 L233
SP017005	MN 300G 2.0/4.0 L632
SP022424	MN FLEX 300G 2,0/2,4 L234
SP023117	MN 400G HD



Wire liners	
W012361	MN 0,9-1,2 FE / 3,5 M Ø 5,6/1,8 RD STEEL
W012363	MN 1,2-1,6 FE / 3,5 M Ø 5,8/2,4 YE STEEL



Wire guide tube	
SP011869	Guide tube out 1.2 OG plastic

Consumables

 GX428W35, GX428W5, GX428W35N250, GX428W5N250

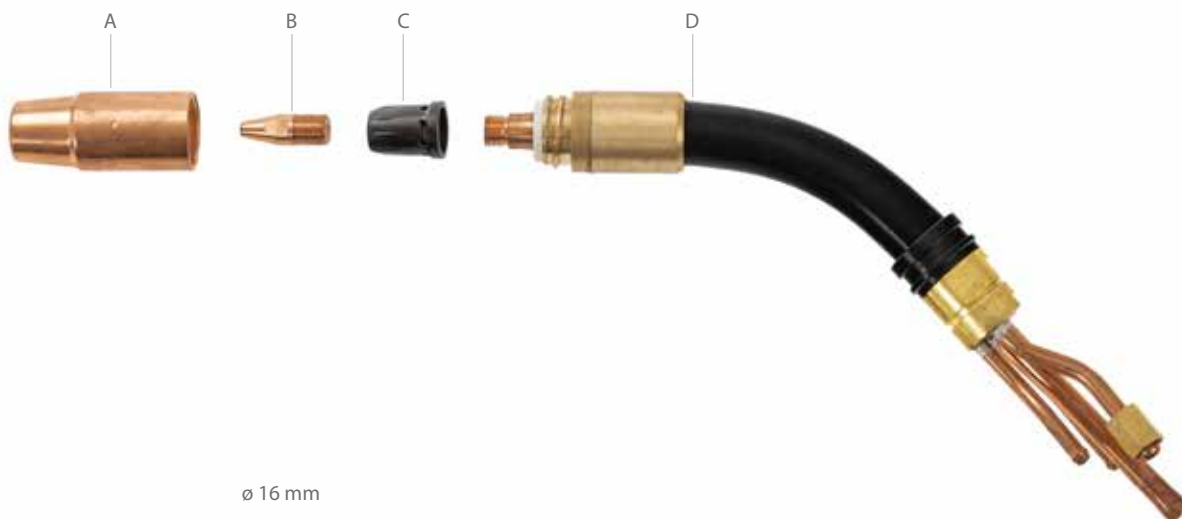

A. Gas nozzle	
W013930	Ø 25 Thread, L61 / OD25 / D16

D. Gun neck	
SP012594	420W
SP013770	420W, L=250



B. Contact tip	
CT10C1SD001	1.0 C1 STD M10



Wire liners	
W013628	0,9-1,2 FE / 3,5M Ø 5,3/1,8 RD STEEL
W013632	0,9-1,2 FE / 5M Ø 5,3/1,8 RD STEEL



C. Contact tip adapter	
W013203	M10, insulated
W011483	M10



Wire guide tube	
SP013597	1.0 / 4.9 RD plastic

Consumables

 GX528W35, GX528W5, GX528W35N250, GX528W5N250

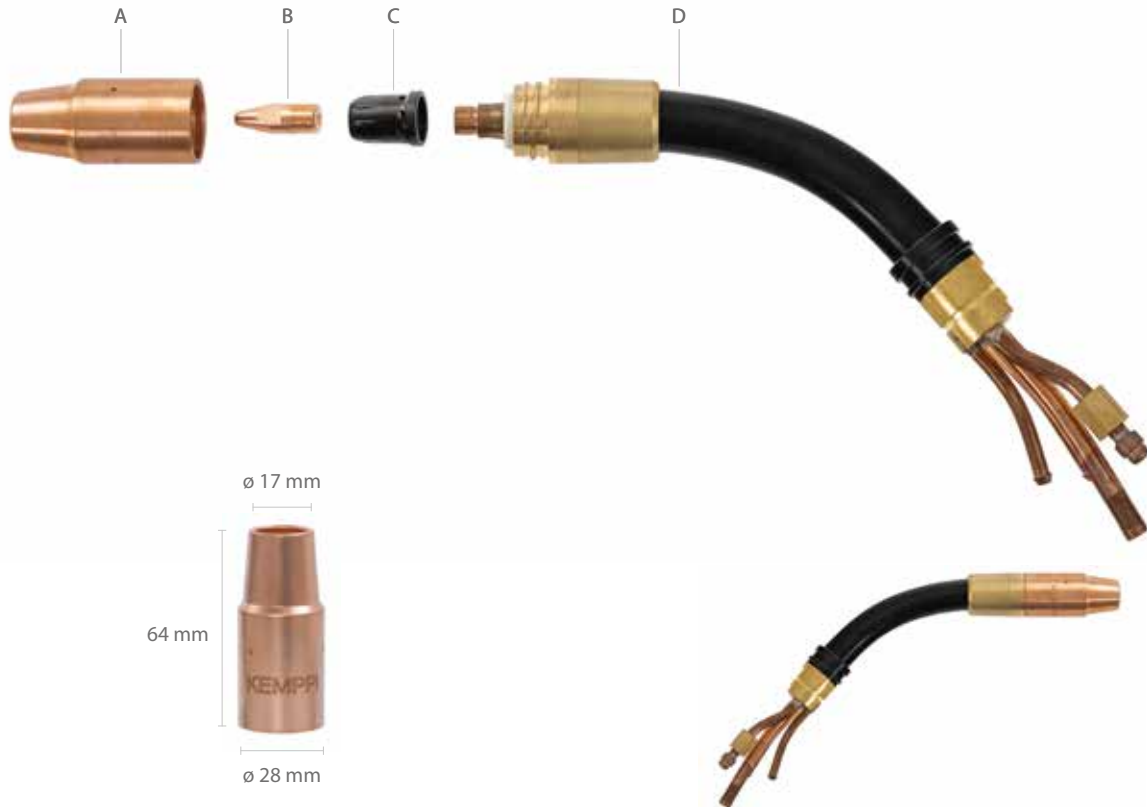

A. Gas nozzle	
W013931	Ø 28 Thread, L64 / OD28 / D17

D. Gun neck	
SP012561	520W
SP013778	520W, L=250



B. Contact tip	
CT12C1SD001	1.2 C1 STD M10



Wire liners	
W013628	0,9-1,2 FE / 3,5M Ø 5,3/1,8 RD STEEL
W013632	0,9-1,2 FE / 5M Ø 5,3/1,8 RD STEEL



C. Contact tip adapter	
W013203	M10, insulated
W011483	M10



Wire guide tube	
SP013598	1.2 / 4.9 OG plastic

Consumables

 GX608W5

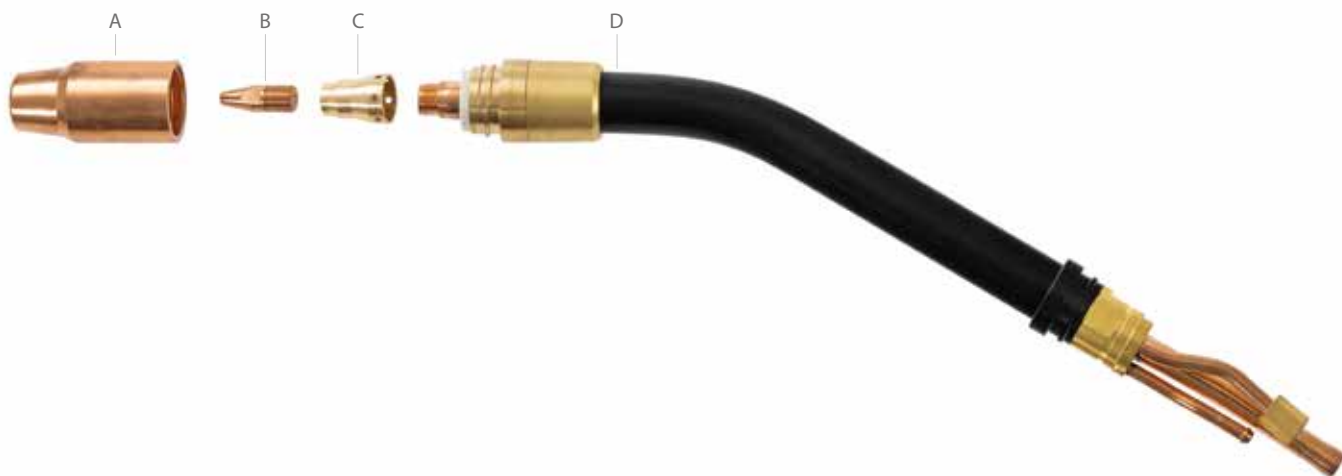

A. Gas nozzle	$\varnothing 30$
W012793	Thread, L64 / OD30 / D17



D. Gun neck	
SP012776	600W



B. Contact tip	
CT12C1SD001	1.2 C1 STD M10



Wire liners	
W012614	1,2-1,6 FE / 5,0 M $\varnothing 5,8/2,4$ YE STEEL



C. Contact tip adapter	
W012810	M10, 600W



Wire guide tube	
SP011869	1.2 OG plastic

Consumables

 GX428WS8*

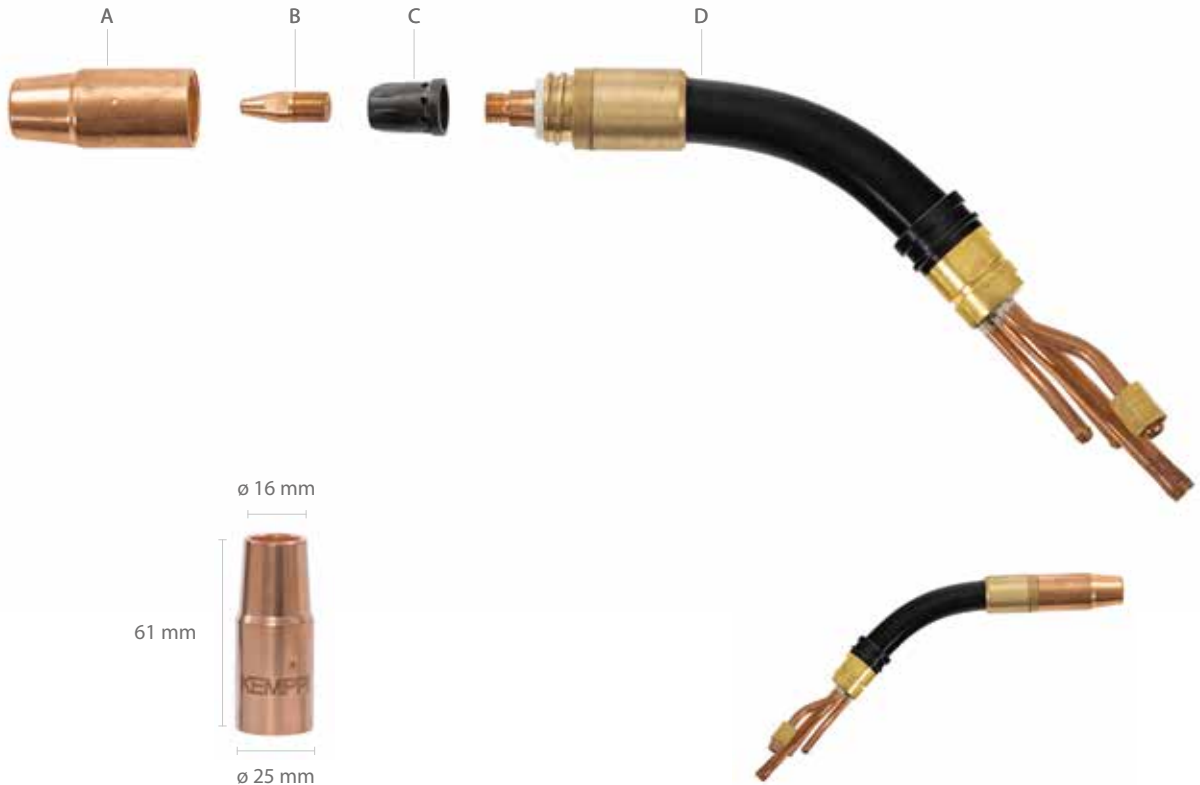

A. Gas nozzle	Ø 25
W013930	Thread, L61 / OD25 / D16

D. Gun neck	
SP012594	420W
SP013770	420W, L=250



B. Contact tip	
CT12C1SD001	1.2 C1 STD M10



Wire liners	
W016312	1,0-1,2 SS, (FE) / 8,0M Ø 5,9/2,0 CHILI



C. Contact tip adapter	
W013203	M10, insulated



Wire guide tube	
SP011869	1.2 OG plastic

* Model delivered without a wire liner. For ordering codes, see page 68.

Consumables

 GX303GHD35, GX303GHD5, GX305GHD35, GX305GHD5

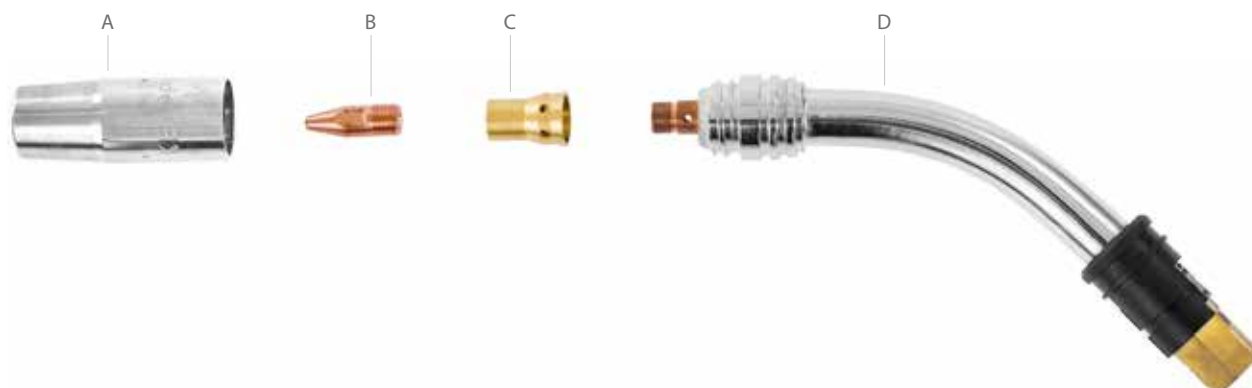

A. Gas nozzle	Ø 25
W021179	GAS NOZZLE HD THREAD, L61 / OD25 / D16



D. Gun neck	
SP022681	300G HD



B. Contact tip	
CT10C1LP002	CONTACT TIP 1.0 C1 LIFE M10



Wire liners	
W013628	WIRE LINER 0,9-1,2 FE / 3,5M Ø 5,3/1,8 RD STEEL
W013632	WIRE LINER 0,9-1,2 FE / 5M Ø 5,3/1,8 RD STEEL



C. Contact tip adapter	
W011483	M10



Wire guide tube	
SP022778	Long nut euro 1-piece small

Consumables

 GX403GHD35, GX403GHD5, GX405GHD35, GX405GHD5

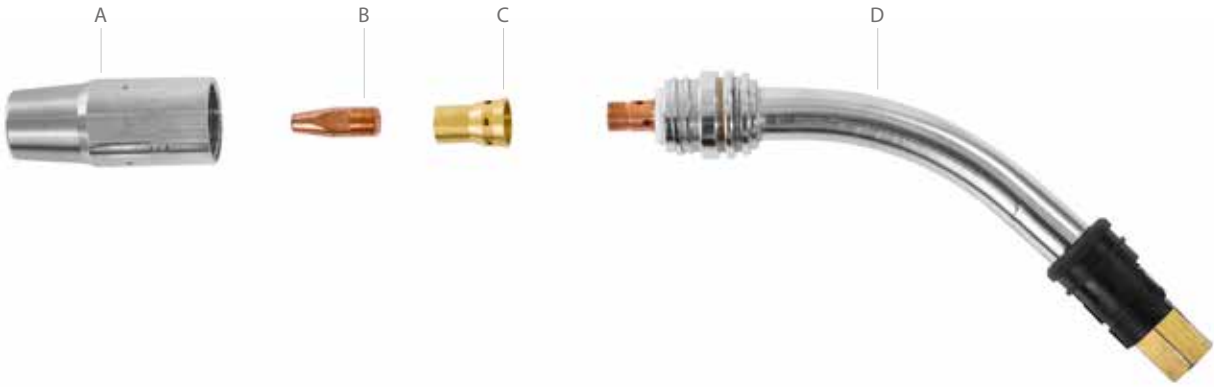

A. Gas nozzle	
W021186	Ø 28 GAS NOZZLE HD THREAD, L64 / OD28 / D17



D. Gun neck	
SP022314	400G HD



B. Contact tip	
CT12C1LP002	CONTACT TIP 1.2 C1 LIFE M10



Wire liners	
W013628	WIRE LINER 0,9-1,2 FE / 3,5M Ø 5,3/1,8 RD STEEL
W013632	WIRE LINER 0,9-1,2 FE / 5M Ø 5,3/1,8 RD STEEL



C. Contact tip adapter	
W011483	M10



Wire guide tube	
SP022778	Long nut euro 1-piece small

Factory-installed consumables

GAS-COOLED FLEXLITE GX WELDING GUNS

	CT10C1SD001	CT12C1SD001	CT10C1SD003	CT12C1LP002	CT10C1LP002	9580173	W013203	W011483	9591079	958010101	W014452	W011478	W011472	W021179	W021186	W013628	W013632	W012361	W012362	SP012239	SP012202	SP012236	SP022778	SP022872	SP011868	SP011869	
	CONTACT TIP 1.0 C1 STD M10	CONTACT TIP 1.2 C1 STD M10	CONTACT TIP 1.0 C1 STD M6	CONTACT TIP 1.2 C1 LIFE M10	CONTACT TIP 1.0 C1 LIFE M10	CONTACT TIP ADAPTER MT18. 25	CONTACT TIP ADAPTER M10, INSULATED	CONTACT TIP ADAPTER M10	INSULATING RING NECK	GAS NOZZLE WITH INSULATING BUSH	GAS NOZZLE, THREAD, L57 / OD22 / D14	GAS NOZZLE, THREAD, L57 / OD25 / D15	GAS NOZZLE, THREAD, L60 / OD28 / D15	GAS NOZZLE, HD THREAD, L61 / OD25 / D16	GAS NOZZLE, HD THREAD, L64 / OD28 / D17	WIRE LINER 0.9-1.2 FE / 3.5 M Ø 5.3 / 1.8 RD STEEL	WIRE LINER 0.9-1.2 FE / 5 M Ø 5.3 / 1.8 RD STEEL	WIRE LINER MN 0.9-1.2 FE / 3.5 M RD STEEL	WIRE LINER MN 0.9-1.2 FE / 5.0 M RD STEEL	NECK LINER MN 200G 2.0/4.0 L=171	NECK LINER MN 300G 2.0/4.0 L=191	NECK LINER MN 400G 2.0/4.0 L=216	LONG NUT EURO 1-PIECE SMALL	LONG NUT EURO 1-PIECE LARGE	GUIDE TUBE GUN 1.0 RD PLASTIC	GUIDE TUBE GUN 1.2 OG PLASTIC	
GX203G35	•						•				•					•							•				
GX203G5	•						•				•						•							•			
GX205G35	•						•				•					•								•			
GX205G5	•						•				•						•							•			
GX208GMN35	•						•					•						•		•						•	
GX208GMN5	•						•					•						•		•						•	
GX253G35			•			•			•	•						•								•			
GX253G5			•			•			•	•							•							•			
GX255G35			•			•			•	•						•								•			
GX255G5			•			•			•	•							•							•			
GX303G35	•						•					•				•								•			
GX303G5	•						•					•					•							•			
GX303GHD35					•			•						•		•								•			
GX303GHD5					•			•						•			•							•			
GX305G35	•						•					•				•								•			
GX305G5	•						•					•					•							•			
GX305GMN35	•						•					•						•		•					•		
GX305GMN5	•						•					•						•		•					•		
GX305GHD35					•			•						•		•								•			
GX305GHD5					•			•						•			•							•			
GX305GS6		•					•					•													•		
GX305GS8		•					•					•													•		
GX308GMN35	•						•					•						•		•						•	
GX308GMN5	•						•					•						•		•						•	
GX403G35		•					•					•				•								•			
GX403G5		•					•					•					•							•			
GX403GHD35				•				•							•	•								•			
GX403GHD5				•				•							•	•								•			
GX405G35		•					•					•				•								•			
GX405G5		•					•					•					•							•			
GX405GHD35				•				•							•	•								•			
GX405GHD5				•				•							•	•								•			
GX408GMN35		•					•					•						•		•					•		•
GX408GMN5		•					•					•						•		•					•		•

WATER-COOLED FLEXLITE GX WELDING GUNS

	CTT10C1SD001	CONTACT TIP 1.0 C1 STD M10	CTT12C1SD001	CONTACT TIP 1.2 C1 STD M10	W013203	CONTACT TIP ADAPTER M10, INSULATED	W012810	CONTACT TIP ADAPTER M10, 600W	W014452	GAS NOZZLE, THREAD, L57 / OD22 / D14	W011478	GAS NOZZLE, THREAD, L57 / OD25 / D15	W013930	GAS NOZZLE, THREAD, L61 / OD25 / D16	W011472	GAS NOZZLE, THREAD, L60 / OD28 / D15	W013931	GAS NOZZLE, THREAD, L64 / OD28 / D17	W012793	GAS NOZZLE, THREAD, L64 / OD30 / D17	W013628	WIRE LINER 0.9-1.2 FE / 3.5 M Ø 5.3 / 1,8 RD STEEL	W013632	WIRE LINER 0.9-1.2 FE / 5.0 M Ø 5.3 / 1,8 RD STEEL	W012614	WIRE LINER 1.2-1.6 FE / 5.0 M YE STEEL	SP022778	LONG NUT EURO 1-PIECE SMALL	SP022872	LONG NUT EURO 1-PIECE LARGE	SP013597	GUIDE TUBE GUN 1.0 / 4.9 RD PLASTIC	SP013598	GUIDE TUBE GUN 1.2 / 4.9 OG PLASTIC	SP011869	GUIDE TUBE GUN 1.2 OG PLASTIC							
GX303W35	•				•				•													•																					
GX303W5	•				•				•															•																			
GX305W35	•				•				•														•																				
GX305W5	•				•				•															•																			
GX305W56			•		•				•																											•							
GX403W35	•				•					•													•																				
GX403W5	•				•					•														•																			
GX405W35	•				•					•													•																				
GX405W5	•				•					•														•																			
GX405W56			•		•					•																												•					
GX405W58			•		•					•																												•					
GX428W35	•				•									•									•															•					
GX428W5	•				•									•										•														•					
GX428W58			•		•									•																										•			
GX503W35			•		•										•								•																				
GX503W5			•		•										•									•																			
GX505W35			•		•										•								•																				
GX505W5			•		•										•									•																			
GX528W35			•		•											•							•																		•		
GX528W5			•		•											•								•																•			
GX605W5			•				•															•							•							•							
GX608W5			•				•															•							•													•	

Technical data and ordering codes

SERIES 3

Flexlite GX		253G	203G	303G	303GHD	403G	403GHD	303W	403W	503W
Welding process		MIG/MAG	MIG/MAG	MIG/MAG	MIG/MAG	MIG/MAG	MIG/MAG	MIG/MAG	MIG/MAG	MIG/MAG
Contact tip		M6	M10	M10	M10	M10	M10	M10	M10	M10
Type of cooling		Gas	Gas	Gas	Gas	Gas	Gas	Water	Water	Water
Type of connection		Euro	Euro	Euro	Euro	Euro	Euro	Euro	Euro	Euro
Wire diameters (mm)		0.6–1.2	0.8–1.2	0.8–1.2	0.8-1.2	0.8–1.6	0.8-1.6	0.8–1.6	0.8–1.6	0.8–1.6
Load capacity (IEC 60974-7)										
35% / Ar + 18% CO ₂		250 A	200 A	300 A	300 A	400 A	400 A			
60% / Ar + 18% CO ₂										
100% / Ar + 18% CO ₂								300 A	400 A	500 A
Pistol grip handle		Yes	Yes	Yes	Yes	Yes	Yes	Yes	Yes	Yes
Remote control option		No	No	No	No	No	No	No	No	No
LED option		No	No	No	No	No	No	No	No	No
Rotating neck		Yes	Yes	Yes	Yes	Yes	Yes	No	No	No
Changeable neck		No	No	No	No	No	No	No	No	No
Ordering codes	3.5 m	GX253G35	GX203G35	GX303G35	GX303GHD35	GX403G35	GX403GHD35	GX303W35	GX403W35	GX503W35
	5 m	GX253G5	GX203G5	GX303G5	GX303GHD5	GX403G5	GX403GHD5	GX303W5	GX403W5	GX503W5

SERIES 5

Flexlite GX		255G	205G	305G	305GHD	405G	405GHD	305W	405W	505W
Welding process		MIG/MAG	MIG/MAG	MIG/MAG	MIG/MAG	MIG/MAG	MIG/MAG	MIG/MAG	MIG/MAG	MIG/MAG
Contact tip		M6	M10	M10	M10	M10	M10	M10	M10	M10
Type of cooling		Gas	Gas	Gas	Gas	Gas	Gas	Water	Water	Water
Type of connection		Euro	Euro	Euro	Euro	Euro	Euro	Euro	Euro	Euro
Wire diameters (mm)		0.6–1.2	0.8–1.2	0.8–1.2	0.8-1.2	0.8–1.6	0.8-1.6	0.8–1.6	0.8–1.6	0.8–1.6
Load capacity (IEC 60974-7)										
35% / Ar + 18% CO ₂		250 A	200 A	300 A	300 A	400 A	400 A			
60% / Ar + 18% CO ₂										
100% / Ar + 18% CO ₂								300 A	400 A	500 A
Pistol grip handle		Yes	Yes	Yes	Yes	Yes	Yes	Yes	Yes	Yes
GXR10 Gun Remote (ordering code: GXR10)		Yes	Yes	Yes	Yes	Yes	Yes	Yes	Yes	Yes
LED option		No	No	No	No	No	No	No	No	No
Rotating neck		Yes	Yes	Yes	Yes	Yes	Yes	No	No	No
Changeable neck		No	No	No	No	No	No	No	No	No
Ordering codes	3.5 m	GX255G35	GX205G35	GX305G35	GX305GHD35	GX405G35	GX405GHD35	GX305W35	GX405W35	GX505W35
	5 m	GX255G5	GX205G5	GX305G5	GX305GHD5	GX405G5	GX405GHD5	GX305W5	GX405W5	GX505W5

SERIES 5

Flexlite GX		605W	305GMN	305GS	305WS	405WS
Welding process		MIG/MAG	MIG/MAG	MIG/MAG	MIG/MAG	MIG/MAG
Contact tip		M10	M10	M10	M10	M10
Type of cooling		Water	Gas	Gas	Water	Water
Type of connection		Euro	Euro	Euro	Euro	Euro
Wire diameters (mm)		1.2–2.4	0.8–1.2	1.0–1.2	1.0–1.6	1.0–1.6
Load capacity (IEC 60974-7)						
35% / Ar + 18% CO ₂		600 A (40%)	350 A	300 A		
60% / Ar + 18% CO ₂						
100% / Ar + 18% CO ₂					250 A	300 A
Pistol grip handle		Yes	Yes	Yes	Yes	Yes
GXR10 Gun Remote (ordering code: GXR10)		Yes	Yes	Yes	Yes	Yes
LED option		No	No	No	No	No
Rotating neck		No	Yes	Yes	No	No
Changeable neck		No	Yes	No	No	No
Ordering codes	3.5 m		GX305GMN35			
	5 m	GX605W5	GX305GMN5			
	6 m			GX305GS6	GX305WS6	GX405WS6
	8 m			GX305GS8		GX405WS8

SERIES 8

Flexlite GX		208GMN	308GMN	408GMN	428W	528W	608W	428WS
Welding process		MIG/MAG	MIG/MAG	MIG/MAG	MIG/MAG	MIG/MAG	MIG/MAG	MIG/MAG
Contact tip		M10	M10	M10	M10	M10	M10	M10
Type of cooling		Gas	Gas	Gas	Water	Water	Water	Water
Type of connection		Kemppi	Kemppi	Kemppi	Kemppi	Kemppi	Kemppi	Kemppi
Wire diameters (mm)		0.8–1.2	0.8–1.2	0.8–1.6	0.8–1.6	0.8–1.6	1.2–2.4	1.2–1.6
Load capacity (IEC 60974-7)								
35% / Ar + 18% CO ₂							600 A (40%)	
60% / Ar + 18% CO ₂		200 A	300 A	400 A				
100% / Ar + 18% CO ₂					420 A	520 A		300 A
Pistol grip handle		Yes	Yes	Yes	Yes	Yes	Yes	Yes
Remote control option		Yes*	Yes*	Yes*	Yes*	Yes*	Yes*	Yes*
LED option		Yes	Yes	Yes	Yes	Yes	Yes	Yes
Rotating neck		Yes	Yes	Yes	No	No	No	No
Changeable neck		Yes	Yes	Yes	No	No	No	No
Ordering codes	3.5 m	GX208GMN35	GX308GMN35	GX408GMN35	GX428W35	GX528W35		
	5 m	GX208GMN5	GX308GMN5	GX408GMN5	GX428W5	GX528W5	GX608W5	
	8 m							GX428WS8

NOTE: Extra long S models are delivered without a wire liner. For wire liner ordering codes, see page 68.

*No remote control available 2022

FLEXLITE GC

Reliable Kemppi entry-level MIG gun for all welders

Flexlite GC product series contains five lightweight and robust entry-level welding gun models for MIG/MAG welding processes. The welding guns models are equipped either with Euro or MMG connector. All Flexlite GC models enjoy extended consumable part life.



Visit website:
> <https://kemp.cc/flexlite-gc/com-en>



Flexlite GC offers a great deal of benefits for Kemppi entry-level MIG welding guns

Flexlite GC offers a good choice for MIG/MAG welders who appreciate an easy-to-use welding gun equipped with a durable and flexible coaxial cable. As an additional accessory, Flexlite GC is equipped with a detachable, ergonomic pistol grip handle. When in use, the handle gives a firm grip and improves welding ergonomics especially during long welds.

In a class of its own, the Flexlite GC welding gun is also available with a rotatable neck that gives you easy access to welded workpieces, enhancing the welder's ergonomics.

Flexlite GC uses the same consumable parts as standard Flexlite GX models. Less individual parts in workshop storage streamlines inventory management and lowers inventory costs.



LONG CONSUMABLE LIFE

Durable Kemppi consumables support welding quality and productivity.



LESS PARTS, LOW COSTS

Streamline your workshop inventory costs with fewer consumable parts.



ENHANCED ERGONOMICS

Optional pistol grip handle with a firm grip allows a natural position for the wrist, improving work quality.



Flexlite GC Models

Series 3		page
Flexlite GC 223G Load capacity: 220A/35% Cooling: gas Length: 3 m		44
Flexlite GC 253G Load capacity: 250A/35% Cooling: gas Length: 3.5 m / 5 m		44
Flexlite GC 323G Load capacity: 320A/35% Cooling: gas Length: 3.5 m / 5 m		45

The name of a Flexlite welding gun tells its properties and use

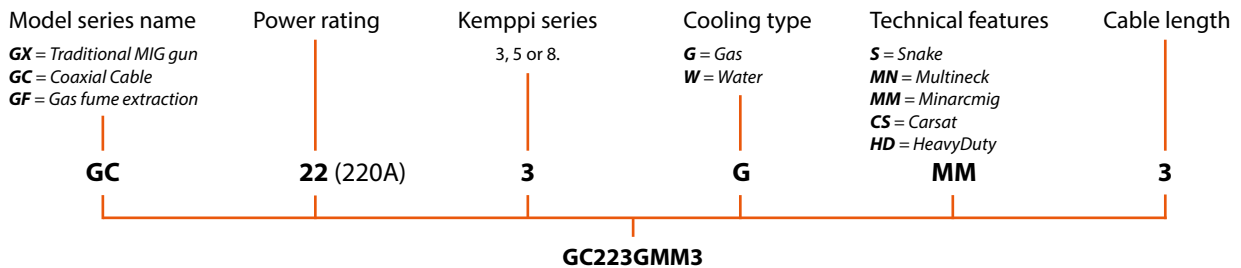

Factory-installed consumables

	CT10C1SD001	CT08C1SD003	CT10C1SD003	9580173	W013203	9591079	958010101	W011478	4307650	W006453	W006454	SP022778
	CONTACT TIP 1.0 C1 STD M10	CONTACT TIP 0,8 C1 STD M6	CONTACT TIP 1.0 C1 STD M6	CONTACT TIP ADAPTER M6	CONTACT TIP ADAPTER M10, INSULATED	INSULATING RING NECK	GAS NOZZLE WITH INSULATING BUSH	GAS NOZZLE, THREAD, L57 / OD25 / DI5	WIRE LINER 0,6- 1,0 / 3350 3M Ø 4,7/1,5 STEEL, MMG	WIRE LINER 0,9- 1,2 FE / 3,5 M Ø 4,7/2,0 RD STEEL	WIRE LINER 0,9-1,2 FE / 5 M Ø 4,7/2,0 RD STEEL	LONG NUT EURO 1-PIECE SMALL
GC223GMM3		●		●		●	●		●			
GC253G35			●	●		●	●			●		●
GC253G5			●	●		●	●				●	●
GC323G35	●				●			●		●		●
GC323G5	●				●			●			●	●

Technical data and ordering codes

SERIES 3

Flexlite GC		223	253G	323G
Welding process		MIG/MAG	MIG/MAG	MIG/MAG
Contact tip		M6	M6	M10x1
Type of cooling		Gas	Gas	Gas
Type of connection		MinarcMig	Euro	Euro
Wire diameters (mm)		0.6-1.0	0.8-1.2	0.8-1.2
Load capacity (IEC 60974-7)				
35% / Ar + 18% CO ₂		220	250	320
Pistol grip handle		Yes	Yes	Yes
Rotating neck		Yes	Yes	Yes
Changeable neck		No	No	No
Ordering codes	3 m	GC223GMM3		
	3.5 m		GC253G35	GC323G35
	5 m		GC253G5	GC323G5

Consumables

 GC223GMM3, GC253G35, GC253G5



A. Gas nozzle	
958010101	Gas nozzle with insulating bush



D. Gun neck	
SP4153040	250G



B. Contact tip	
CT08C1SD003	CONTACT TIP 0.8 C1 STD M6
CT10C1SD003	CONTACT TIP 1.0 C1 STD M6



Wire liners	
4307650	0,6-1,0 / 3350 3M Ø 4,7/1,5 STEEL, MMG
W006453	0,9-1,2 FE / 3,5M Ø 4,7/2,0 RD STEEL
W006454	0,9-1,2 FE / 5M Ø 4,7/2,0 RD STEEL



C. Contact tip adapter	
9580173	Contact tip adapter M6



Wire guide tube	
SP022778	Long nut euro 1-piece small

Consumables

 GC323G35, GC323G5

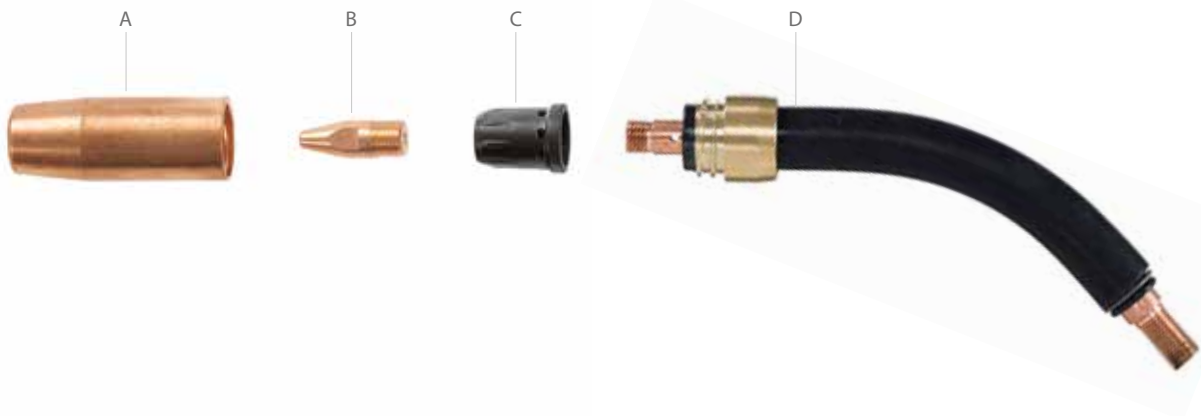

A. Gas nozzle	Ø 25
W011478	Thread, L57 / OD25 / D15



D. Gun neck	
SP020428	300G



B. Contact tip	
CT10C1SD001	1.0 C1 STD M10



Wire liners	
W006453	0,9-1,2 FE / 3,5M Ø 4,7/2,0 RD STEEL
W006454	0,9-1,2 FE / 5M Ø 4,7/2,0 RD STEEL



C. Contact tip adapter	
W013203	M10, insulated



Wire guide tube	
SP022778	Long nut euro 1-piece small

FLEXLITE GF

Grip on safety

The **Flexlite GF product series** consists of several MIG/MAG welding guns with a fume-extraction function. The efficient vacuum system extracts the welding fumes directly from the gun nozzle without disturbing the shielding gas flow, thus providing a safer and cleaner working environment for the welder as well as for others sharing the working environment.

The Flexlite GF is available in water- and gas-cooled versions, both featuring excellent ergonomics provided by the detachable pistol grip handle. The design and the shape of the grip handle make it a delight to hold. All Flexlite GF models enjoy the Flexlite features for user comfort, welding efficiency and extended consumable part life.

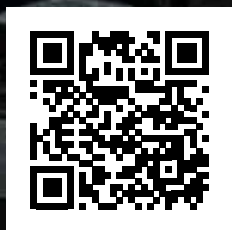

Visit website:

> <https://kemp.cc/flexlite-gf/com-en>



Flexlite GF provides a safer working environment

When working with the Flexlite GF, a primary protection is ensured for the entire working environment, including both people and fume-sensitive devices. Comprehensive testing has proved that the welding properties are not compromised when using fume extraction.

Moreover, the Flexlite GF has been tested against the ISO 21904-3 standard. This ensures a standardized way to prove the capture efficiency of the gun. The standardized welding gun is a safe and reliable tool for a welder's day-to-day work.



PROTECTION AT ITS BEST

Welding fumes are removed directly from the contaminant source, which means high-class protection not only for the welder, but to everyone around them.



WELDING OUTPERFORMED

Safety adds up to excellent welding properties and reduced spatter.



HAPPY TO HOLD

Excellent ergonomics makes welding with the Flexlite GF a pleasure, and results in increased work quality and efficiency.



Welding fume is composed of elements dangerous to human health.



One single welding operator can produce up to 40 g of air-borne fume and particulate per hour.

4000

Typically, we breath 4000 litres of air per 8-hour work shift.



Fume extraction improves safety of all people who work in same environment.



Occupational lung diseases are preventable by proper fume extraction



If unprotected, tiny fume particles can pass deep into the lung structure.



Extraction efficiency has been measured according to new standard.



If exposed for lengthy periods, may result in long term health issues, including cancer.

The most efficient fume-extraction method

All welding processes produce smoke that contains harmful metal fumes and gases which are invisible to the eye. One single welding operator can produce up to 40 grams of airborne fumes and particles per hour. These welding fumes are composed of elements that are dangerous to human health. Exposure to airborne contamination for lengthy periods may result in long-term health issues, including cancer.

The fume-extraction gun enables the extraction of welding fumes in challenging locations where it is difficult to arrange localized ventilation. An efficient fume-extraction gun, such as the Flexlite GF, collects up to 95 % of welding fumes directly as they are generated, and long before they reach the welder's breathing zone. All Kemppi's welding fume extraction gun models and their extraction efficiency has been measured according to new standard ISO 21904-3.

Fume-extraction guns are not the only option for removing airborne welding fumes and particles, but in many cases, they are the best. Fume-extraction guns are the only solution that removes the welding fumes directly at source.





Flexlite GF

Safety comes first

The Flexlite GF offers primary protection not only for the welder but also for others sharing the same working environment. The efficient and adjustable vacuum flow removes 95 % of airborne fumes and particles before they reach breathing zones.

When you have highly sensitive equipment and devices in your working environment, top-class protection is required. Removing fumes directly from the contaminant source with a fume-extraction gun is the most reliable and economic solution available in the market.

HIGH-QUALITY TOOLS FOR HIGH-QUALITY WELDS

The Flexlite GF combines powerful fume extraction and comprehensive shielding gas coverage. As well as maximum protection, this also results in premium welding work. With the help of a high-performance gun, the power source capacity is used efficiently, and the spatters are minimized.

Kemppi's comprehensive testing ensures that the use of fume extraction does not compromise welding abilities. With the Flexlite GF, the welding performance can reach a new level in terms of safety and welding capability. The Flexlite GF is compatible with standard Flexlite GX consumables. The original consumables boast a long lifecycle and durability.





In several cases, welding happens in difficult positions which may cause excessive fatigue, and even occupational injuries. The excellent ergonomics of lightweight Flexlite GF reduces injury risks and allows a welder to weld longer periods of time and more efficiently.

Combined safety and usability

In the Flexlite GF, safety has found its match in usability. The excellent ergonomics are one of the distinguishing features of our Flexlite product family and provide the welder with a comfort beyond comparison.

The Flexlite design lessens the welder fatigue, which leads to increased work quality and efficiency. An average welder spends around 20% of the working day holding a welding gun. The detachable pistol grip handle and a well-balanced gun shape make the work smoother and the gun so light that you do not have to worry about it. The flexible cable set goes up to 5 meters, and the ball-jointed cable protection offers additional comfort – you will be happy to hold the Flexlite GF.



The removable pistol grip handle makes welding position more natural and ergonomic. The pistol grip handle is included in the standard delivery specification.



Fume extraction unit connector has a flexible vacuum outlet which rotates freely 360°.

Risk minimized,

ERGONOMIC HANDLE DESIGN

An anatomically shaped handle with a firm grip. A modular trigger with few parts and simple wiring. The handle cover and trigger are quick and easy to change.

LESS PARTS, LOWER COSTS

The number of changeable parts has been reduced by improving cross-matching across corresponding models, and by combining the functions of some of the consumables. This lowers inventory costs and makes the Flexlite perfect for workshop cost management.

ADJUSTABLE VACUUM NOZZLE POSITION

The vacuum nozzle can be adjusted to three set positions to regulate the fume extraction airflow. Always optimized fume extraction for your welding job.

CONTACT TIP ADAPTER

The combined contact tip adapter and gas diffuser offer an improved gas shield with smooth laminar flow. The combination results in need for fewer consumables.

CONTACT TIP M10

Improved heat transfer helps with cooling. The contact tip bore is made by drilling, as a drilled hole is more concentric and accurate, and enables better fillets. Contact tips are marked according to the filler wire diameter, bore clearance class, and contact tip material type.

PISTOL GRIP HANDLE

The detachable pistol grip handle is available for all the models. It allows a natural wrist position, which makes working easier and more effortless, especially when doing long welds. It is quick to install without tools.



welding outperformed



ADJUSTABLE VACUUM FLOW

The airflow bypass valve allows quick and easy adjustment of the extraction airflow during welding. The valve is ergonomically placed at the gun handle.





SUPERB FUME EXTRACTION UNIT CONNECTOR

The connector has a flexible vacuum outlet which rotates freely 360°. This enables an easy connectivity to the fume extraction unit regardless of its placement. A leather cover for the vacuum hose is included as factory-installed in the package. A leather cover can also be supplied as a spare part with a Velcro-type fastener for easy installation. Flexible hoses increase ergonomics.

Flexlite GF

Consumables

 GF303G35, GF303G5

 GF303W35, GF303W5

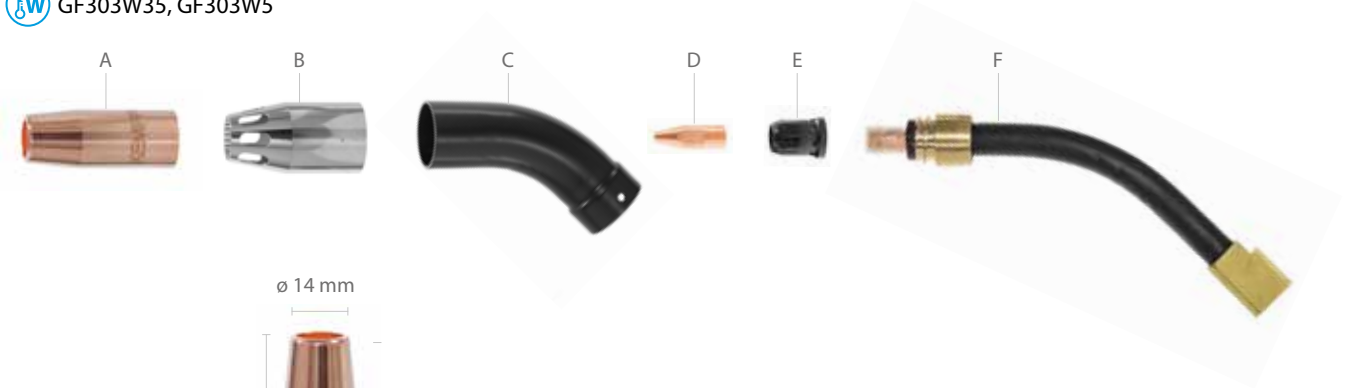

A. Gas nozzle	\varnothing 22
W014452	Thread, L57 / OD22 / D14



E. Contact tip adapter	
W013203	M10, insulated



B. Vacuum nozzle	
SP020810	VACUUM NOZZLE GF 22 MM



F. Gun neck	
SP021213	300G
SP020926	300W



C. Vacuum Tube	
SP020077	VACUUM TUBE GF 45 DEG



Wire liners	
W013628	0,9-1,2 FE / 3,5M \varnothing 5,3/1,8 RD STEEL
W013632	0,9-1,2 FE / 5M \varnothing 5,3/1,8 RD STEEL





D. Contact tip	
CT10C1SD001	1.0 C1 STD M10



Wire guide tube	
SP022778	Long nut euro 1-piece small

Consumables

 GF403G35, GF403G5

 GF403W35, GF403W5

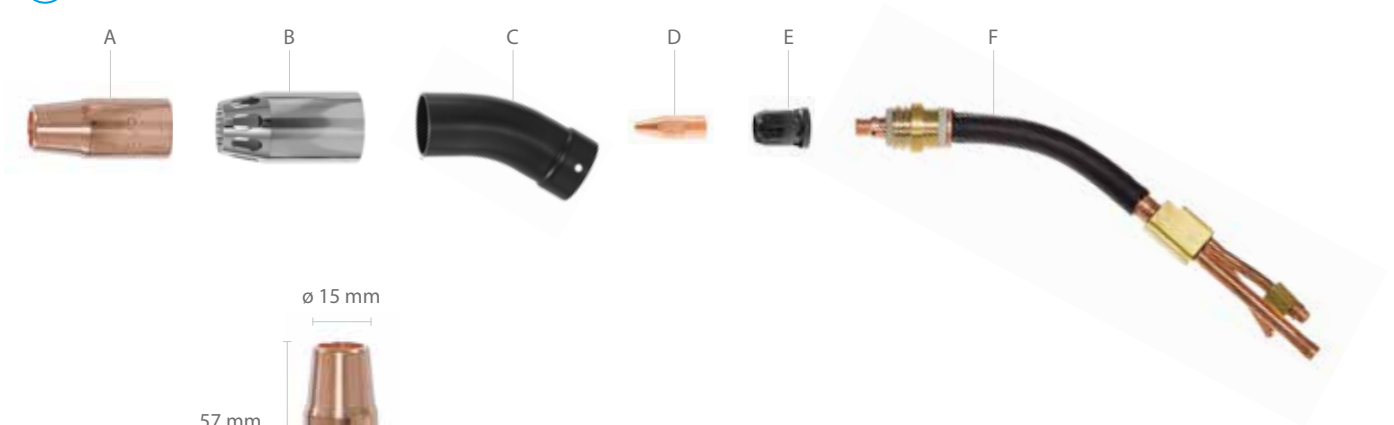

A. Gas nozzle	Ø 25
W011478	Thread, L57 / OD25 / D15



B. Vacuum nozzle	
SP020253	VACUUM NOZZLE GF 25MM



C. Vacuum Tube	
SP020077	VACUUM TUBE GF 45 DEG



D. Contact tip	
CT10C1SD001	1.0 C1 STD M10
CT12C1SD001	1.2 C1 STD M10

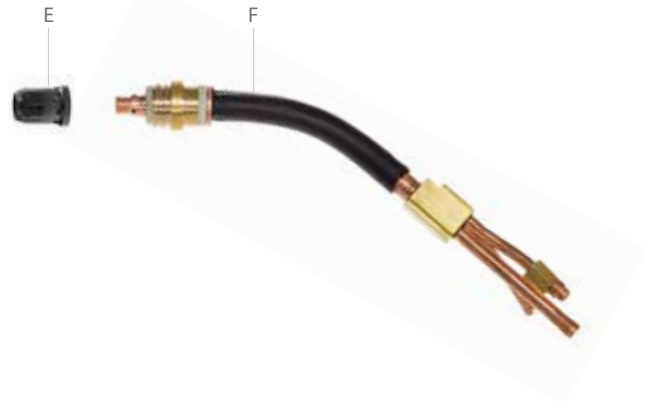

E. Contact tip adapter	
W013203	M10, insulated



F. Gun neck	
SP021316	400G
SP020159	400W



Wire liners	
W013628	0,9-1,2 FE / 3,5M Ø 5,3/1,8 RD STEEL
W013632	0,9-1,2 FE / 5M Ø 5,3/1,8 RD STEEL



Wire guide tube	
SP022778	Long nut euro 1-piece small

Consumables

 GF403GCS30D5

 GF403WCS5, GF403WCS45D5

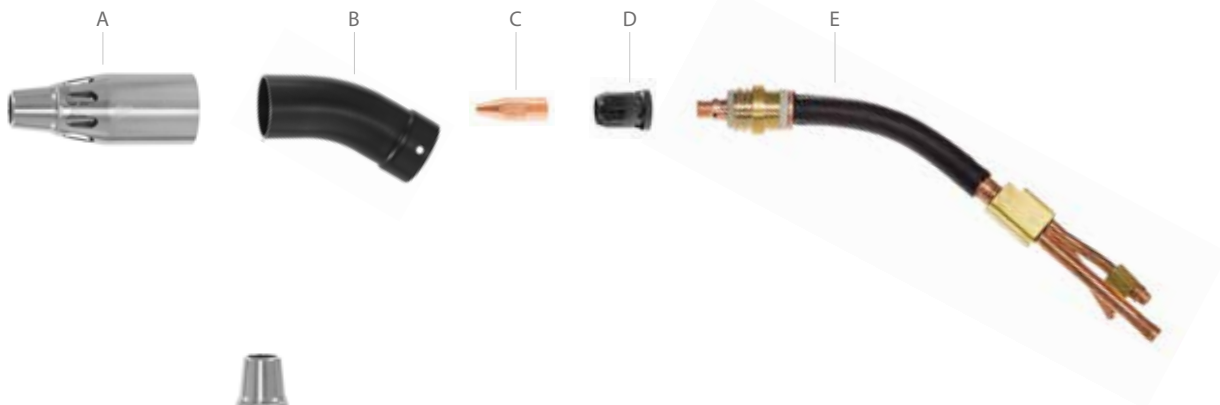



A. Vacuum nozzle + gas nozzle assembly	
SP021260	VACUUM/GAS NOZZLE GF403WCS5



D. Contact tip adapter	
W013203	M10, insulated



B. Vacuum Tube	
SP020077	VACUUM TUBE GF 45 DEG
SP020746	VACUUM TUBE GF 30 DEG



E. Gun neck	
SP022315	400G CS30
SP020159	400W CS45
SP021188	400W



C. Contact tip	
CT12C1SD001	1.2 C1 STD M10



Wire liners	
W013628	0,9-1,2 FE / 3,5M Ø 5,3/1,8 RD STEEL
W013632	0,9-1,2 FE / 5M Ø 5,3/1,8 RD STEEL



Wire guide tube	
SP022778	Long nut euro 1-piece small



Factory-installed consumables

GAS-COOLED FLEXLITE GF WELDING GUNS

	CT10C1SD001	CT12C1SD001	W013203	W014452	W011478	SP020810	SP020253	SP021260	SP020077	SP022624	SP020746	W013628	W013632	SP022778
	CONTACT TIP 1.0 C1 STD M10	CONTACT TIP 1.2 C1 STD M10	CONTACT TIP ADAPTER M10, INSULATED	GAS NOZZLE, THREAD, L57 / OD22 / D14	GAS NOZZLE, THREAD, L57 / OD25 / D15	VACUUM NOZZLE 22MM, GF	VACUUM NOZZLE 25MM, GF	VACUUM / GAS NOZZLE GF GC	VACUUM TUBE GF 45	VACUUM TUBE SHORT GF 45	VACUUM TUBE GF 30	WIRE LINER 0.9-1.2 FE / 3.5 M Ø 5.3 / 1,8 RD STEEL	WIRE LINER 0.9-1.2 FE / 5 M Ø 5.3 / 1,8 RD STEEL	LONG NUT EURO 1-PIECE SMALL
GF303G35	●		●	●		●			●			●		●
GF303G5	●		●	●		●			●				●	●
GF403G35		●	●		●		●		●			●		●
GF403G5		●	●		●		●		●				●	●
GF403GCS30D5		●	●					●			●		●	●

WATER-COOLED FLEXLITE GF WELDING GUNS

	CT10C1SD001	CT12C1SD001	W013203	W014452	W011478	SP020810	SP020253	SP021260	SP020077	SP022624	SP020746	W013628	W013632	SP022778
	CONTACT TIP 1.0 C1 STD M10	CONTACT TIP 1.2 C1 STD M10	CONTACT TIP ADAPTER M10, INSULATED	GAS NOZZLE, THREAD, L57 / OD22 / D14	GAS NOZZLE, THREAD, L57 / OD25 / D15	VACUUM NOZZLE 22 MM, GF	VACUUM NOZZLE 25 MM, GF	GAS / VACUUM NOZZLE GF GC	VACUUM TUBE GF 45	VACUUM TUBE SHORT GF 45	VACUUM TUBE GF 30	WIRE LINER 0.9-1.2 FE / 3.5 M Ø 5.3 / 1,8 RD STEEL	WIRE LINER 0.9-1.2 FE / 5 M Ø 5.3 / 1,8 RD STEEL	LONG NUT EURO 1-PIECE SMALL
GF303W35	●		●	●		●			●			●		●
GF303W5	●		●	●		●			●				●	●
GF403W35	●		●		●		●		●			●		●
GF403W5	●		●		●		●		●				●	●
GF403WCS5		●	●					●			●		●	●
GF403WCS45D5		●	●					●		●			●	●

Technical data and ordering codes

SERIES 3

Flexlite GF		303G	403G	303W	403W
Welding process		MIG/MAG	MIG/MAG	MIG/MAG	MIG/MAG
Contact tip		M10	M10	M10	M10
Type of cooling		Gas	Gas	Water	Water
Type of connection		Euro	Euro	Euro	Euro
Wire diameters (mm)		0.8–1.2	0.8–1.6	0.8–1.6	0.8–1.6
Load capacity (IEC 60974-7)					
35% / Ar + 18% CO ₂		300 A	400 A		
100% / Ar + 18% CO ₂				300 A	400 A
Capture efficiency (ISO 21904-3)		84	84	84	84
Minimum extraction flow (m ³ /h)		57	57	57	57
Pressure difference (Pa)		5500	5500	5500	5500
Pistol grip handle		Yes	Yes	Yes	Yes
Remote control option		No	No	No	No
LED option		No	No	No	No
Rotating neck		Yes	Yes	No	No
Changeable neck		No	No	No	No
Ordering codes	3.5 m	GF303G35	GF403G35	GF303W35	GF403W35
	5 m	GF303G5	GF403G5 GF403GCS30D5	GF303W5	GF403W5 GF403WCS5 GF403WCS45D5

CS = Fixed gas nozzle/Vacuum nozzle for specific markets.

FLEXLITE GF MODELS





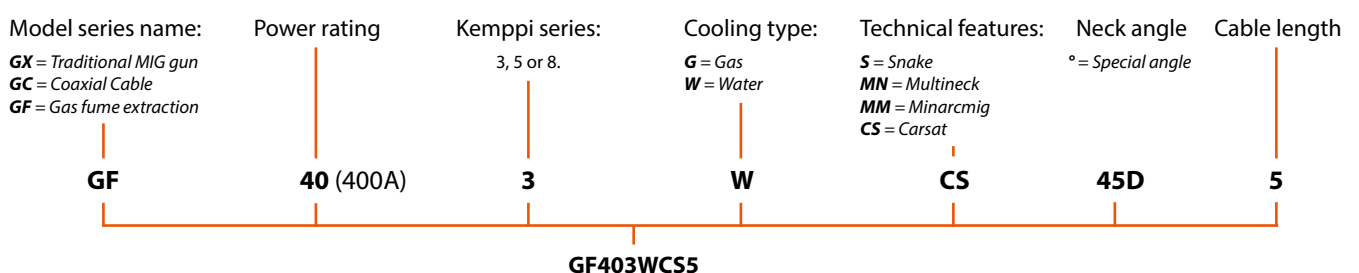















Series 3	page
Flexlite GF 303G Load capacity: 300A/35% Cooling: gas Length: 3.5 m / 5 m	56
Flexlite GF 403G Load capacity: 400A/35% Cooling: gas Length: 3.5 m / 5 m	57
Flexlite GF 303W Load capacity: 300A/100% Cooling: water Length: 3.5 m / 5 m	56
Flexlite GF 403W Load capacity: 400A/100% Cooling: water Length: 3.5 m / 5 m	57

The name of a Flexlite welding gun tells its properties and use

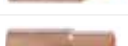

General MIG consumables

Gas nozzles

	Product code	Description	Connection	L mm	OD mm	D mm	Coating	Insulation bush	Technical feature	Picture
ø 18, (20)	9580101	GAS NOZZLE	Socket	61	18	14	Nickel	-		
	958010101	GAS NOZZLE WITH INSULATING BUSH	Socket	61	18	14	Nickel	Yes		
	9580101E	GAS NOZZLE THICK WALL	Socket	61	20	14	Nickel	-	Thick wall	
ø 22	W014452	GAS NOZZLE THREAD, L57 / OD22 / D14	Thread	57	22	14	-	-		
	W015858	GAS NOZZLE THREAD, L60 / OD22 / D15	Thread	60	22	15	-	-		
	W021564	GAS NOZZLE, HD THREAD, L57 / OD22 / D14	Thread	57	22	14	Nickel	-	Thick wall, Heavy Duty	
	W021565	GAS NOZZLE, HD THREAD, L60 / OD22 / D14	Thread	60	22	14	Nickel	-	Thick wall, Heavy Duty	
ø 25	W011478	GAS NOZZLE THREAD, L57 / OD25 / D15	Thread	57	25	15	-	Yes		
	W013930	GAS NOZZLE THREAD, L61 / OD25 / D16	Thread	61	25	16	-	Yes		
	W012143	GAS NOZZLE THREAD, L61 / OD25 / D19	Thread	61	25	19	-	Yes		
	W021173	GAS NOZZLE HD THREAD, L57 / OD25 / D15	Thread	57	25	15	Nickel	Yes	Thick wall, Heavy Duty	
	W021179	GAS NOZZLE HD THREAD, L61 / OD25 / D16	Thread	61	25	16	Nickel	Yes	Thick wall, Heavy Duty	
	W011958	GAS NOZZLE THREAD, L51 / OD25 / D12, ROOT	Thread	51	25	12	-	-	Root	
	W011953	GAS NOZZLE THREAD, L102 / OD25 / D10, NARROW GAP	Thread	102	25	10	-	-	Narrow gap	
ø 28	W011472	GAS NOZZLE THREAD, L60 / OD28 / D15	Thread	60	28	15	-	Yes		
	W013931	GAS NOZZLE THREAD, L64 / OD28 / D17	Thread	64	28	17	-	Yes		
	W012146	GAS NOZZLE THREAD, L64 / OD28 / D21	Thread	64	28	21	-	Yes		
	W021182	GAS NOZZLE HD THREAD, L60 / OD28 / D15	Thread	60	28	15	Nickel	Yes	Thick wall, Heavy Duty	
	W021186	GAS NOZZLE HD THREAD, L64 / OD28 / D17	Thread	64	28	17	Nickel	Yes	Thick wall, Heavy Duty	
ø 30	W012793	GAS NOZZLE THREAD, L64 / OD30 / D17	Thread	64	30	17	-	Yes		

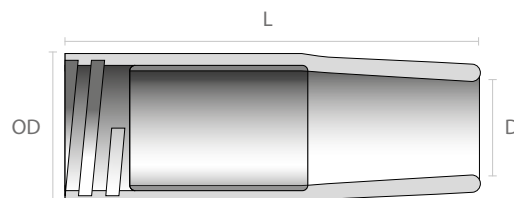

Contact tips

All Kemppi's original M10 contact tips are precision-drilled, high quality consumables. The high-speed drilling produces a much smoother borehole surface, which enables smooth and reliable wire feed and extends contact tip lifetime.

RECOMMENDED FIRST CHOICE

Filler wire Ø	Ferrous wires	Fluxed wires	Stainless wires	Aluminum wires
0.8	C1 (small)		C2 (medium)	C3 (large)
0.9	C1 (small)	C1 (small)	C2 (medium)	C3 (large)
1	C1 (small)	C1 (small)	C2 (medium)	C3 (large)
1.2	C1 (small)	C1 (small)	C2 (medium)	C3 (large)
1.4	C1 (small)	C1 (small)		C3 (large)
1.6	C1 (small)	C1 (small)	C2 (medium)	C3 (large)
2	C3 (large)			C3 (large)
2.4	C3 (large)			C3 (large)

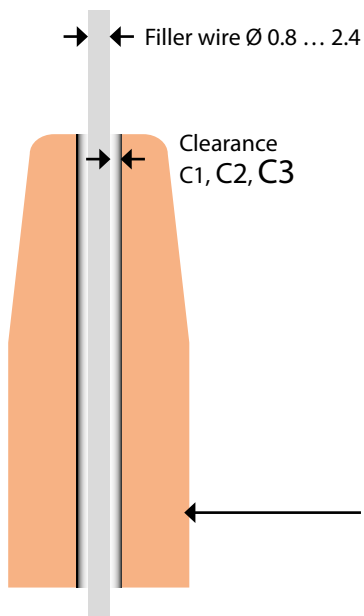

Each filler wire diameter includes three clearance class options:

C1 = Small --> Kemppi recommendation for Ferrous wires

C2 = Medium --> Kemppi recommendation for Stainless wires

C3 = Large --> Kemppi recommendation for Aluminium wires

Just select the class that is the most suitable for your application.

If you experience trouble in high-power welding, you might try selecting a bigger clearance class. A smaller clearance class may have a positive effect on ignition.

Please notice that these are recommendations only.

Material options:

Standard

CuCrZr = longer life time especially with short and globular arc applications

Life+ = longer life time especially with globular and spay arc applications

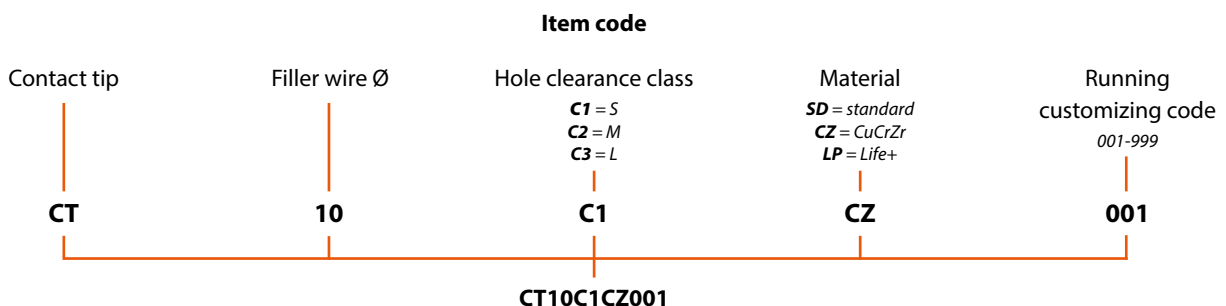

Contact tips, STD



Contact tips, CRZR



Contact tips, LIFE+















Contact tips, narrow gap



Ordering code	Wire Ø, mm	Clearance	Material	Thread
CT08C1SD001	0.8	C1	STD	M10
CT09C1SD001	0.9	C1	STD	M10
CT10C1SD001	1.0	C1	STD	M10
CT12C1SD001	1.2	C1	STD	M10
CT14C1SD001	1.4	C1	STD	M10
CT16C1SD001	1.6	C1	STD	M10
CT08C2SD001	0.8	C2	STD	M10
CT09C2SD001	0.9	C2	STD	M10
CT10C2SD001	1.0	C2	STD	M10
CT12C2SD001	1.2	C2	STD	M10
CT14C2SD001	1.4	C2	STD	M10
CT16C2SD001	1.6	C2	STD	M10
CT08C3SD001	0.8	C3	STD	M10
CT09C3SD001	0.9	C3	STD	M10
CT10C3SD001	1.0	C3	STD	M10
CT12C3SD001	1.2	C3	STD	M10
CT14C3SD001	1.4	C3	STD	M10
CT16C3SD001	1.6	C3	STD	M10
CT20C3SD001	2.0	C3	STD	M10
CT24C3SD001	2.4	C3	STD	M10
CT06C1SD003	0.6	C1	STD	M6
CT08C1SD003	0.8	C1	STD	M6
CT09C1SD003	0.9	C1	STD	M6
CT10C1SD003	1.0	C1	STD	M6
CT12C1SD003	1.2	C1	STD	M6
CT16C1SD003	1.6	C1	STD	M6
CT08C1CZ001	0.8	C1	CRZR	M10
CT09C1CZ001	0.9	C1	CRZR	M10
CT10C1CZ001	1.0	C1	CRZR	M10
CT12C1CZ001	1.2	C1	CRZR	M10
CT16C1CZ001	1.6	C1	CRZR	M10
CT10C2CZ001	1.0	C2	CRZR	M10
CT12C2CZ001	1.2	C2	CRZR	M10
CT16C2CZ001	1.6	C2	CRZR	M10
CT08C1CZ003	0.8	C1	CRZR	M6
CT08C1LP002	0.8	C1	LIFE+	M10
CT10C1LP002	1.0	C1	LIFE+	M10
CT12C1LP002	1.2	C1	LIFE+	M10
CT14C1LP002	1.4	C1	LIFE+	M10
CT16C1LP002	1.6	C1	LIFE+	M10
CT08C2LP002	0.8	C2	LIFE+	M10
CT10C2LP002	1.0	C2	LIFE+	M10
CT12C2LP002	1.2	C2	LIFE+	M10
CT14C2LP002	1.4	C2	LIFE+	M10
CT16C2LP002	1.6	C2	LIFE+	M10
CT10C3LP002	1.0	C3	LIFE+	M10
CT12C3LP002	1.2	C3	LIFE+	M10
CT14C3LP002	1.4	C3	LIFE+	M10
CT16C3LP002	1.6	C3	LIFE+	M10
CT10C1SD004	1.0	C1	STD	M10
CT12C1SD004	1.2	C1	STD	M10

GUN NECK COMPATIBILITY TABLE

● = Standard delivery ○ = Accessory









Gas-cooled necks 			GX 253 G GX 255 G	GX 203 G GX 205 G	GX 303 G GX 305 G	GX 403 G GX 405 G	GX 303 G HD	GX 403 G HD GX 405 G HD	GC 223 G MM	GC 253 G	GC 323 G	GF 303 G	GF 403 G	GF 403 G CS 30
SP014695	NECK 250G, GX		●	○	○	○								
SP014682	NECK 200G, GX		○	●	○	○								
SP013786	NECK 300G, GX		○	○	●	○								
SP014666	NECK 400G, GX		○	○	○	●								
SP021845	NECK 400 G STRAIGHT, GX		○	○	○	○								
SP022681	NECK 300 G HD, GX						●							
SP022314	NECK 400 G HD, GX							●						
SP020428	NECK 300G, GC										●			
SP4153040	NECK 250G, GC								●	●	○			
SP021213	NECK 300G, GF											●		
SP021316	NECK 400G, GF												●	
SP022315	NECK 400 G CS 30, GF													●

Water-cooled necks 			GX 303 W GX 305 W	GX 403 W GX 405 W GX 428 W	GX 503 W GX 505 W GX 528 W	GX 605 W GX 608 W	GF 303 W	GF 403 W	GF 403 W CS	GF 403 W CS 45
SP014957	NECK 300W, GX		●	○	○					
SP012594	NECK 420W, GX		○	●	○					
SP013770	NECK 420W LONG L=250, GX		○	●*	○					
SP012561	NECK 520W, GX		○	○	●					
SP013778	NECK 520W LONG L=250, GX		○	○	●*					
SP012776	NECK 600W LONG L=250, GX		○	○	○	●				
SP020926	NECK 300W, GF						●			
SP020159	NECK 400W, GF							●		●
SP021188	NECK 400W CS, GF								●	

*Only K8 models as factory installed

GUN NECK COMPATIBILITY TABLE

● = Standard delivery ○ = Accessory

Multi necks 			GX 208 G MN	GX 305 G MN GX 308 G MN	GX 408 G MN
SP012415	NECK 200G MN, GX		○ ●	○	○
SP012416	NECK 300G MN, GX		●	●	○
SP012417	NECK 400G MN, GX		○	○	●
SP021121	NECK 300G MN STRAIGHT L=200, GX		○	○	○
SP017001	NECK 300G MN L=600, GX		○	○	○
SP022074	NECK 300G MN FLEX, GX		-	○	-
SP023465	NECK 400G MN HD		○	○	○
SP023178	NECK 400GMN HD STRAIGHT L205		○	○	○



 **KEMPPi**

ITCE
3005



Wire liners

Kemppi wire liners are strong, durable and efficient. Designed to suit specific filler wire materials and applications, Kemppi liners support the filler wire and ensure reliable delivery to the welding arc. The liner selection tables describe gun type, filler material, liner color, ordering code and gun length. Steel spiral liners are suitable for welding solid and cored filler wires of corresponding wire diameter.

Kemppi 'DL Chili' teflon liners are the best solution for reliable feeding of aluminum, stainless steel, acid-resistant and solid steel filler wires. Kemppi's patented technology, two layer DL Chili liner material significantly reduces friction losses between the filler wire material and liner wall, ensuring reliable and worry-free feeding for listed wire types, even in welding guns up to 8 meters in length. Please refer to the following tables to ensure accurate selection of liners for your chosen welding gun and application.

WIRE LINERS FOR FLEXLITE MIG GUN SNAKE MODELS (SERIES 5 AND 8)

Ordering code	Liner type	Liner Ø OD/ID	Length, m	Wire Ø, mm	Material	Cooling	Note
W016311	Chili	5,9 / 2,0	6	1.0-1.2	Ss (Fe)	G / W	GX-S
W016312	Chili	5,9 / 2,0	8	1.0-1.2	Ss (Fe)	G / W	GX-S
W016301	Chili	5,9 / 2,5	6	1.0-1.2	Ss, Al, (Fe)	G / W	GX-S / More wire feed disturbance may occur when welded Al with 6m and 8m gun
W014061	Chili	5,9 / 2,5	8	1.0-1.2	Ss, Al, (Fe)	G / W	GX-S / More wire feed disturbance may occur when welded Al with 6m and 8m gun
W016408	Chili	5,9 / 3,0	6	1.4-1.6	Ss, Al, (Fe)	G / W	GX-S / More wire feed disturbance may occur when welded Al with 6m and 8m gun
W014060	Chili	5,9 / 3,0	8	1.4-1.6	Ss, Al, (Fe)	G / W	GX-S / More wire feed disturbance may occur when welded Al with 6m and 8m gun
W021694	Chili	5,9 / 2,0	6	1,0-1,2	Ss (Fe)	W	GX-S with L250mm neck / More wire feed disturbance may occur when welded Al with 6m and 8m gun
W021695	Chili	5,9 / 2,0	8	1.0-1.2	Ss (Fe)	W	GX-S with L250mm neck / More wire feed disturbance may occur when welded Al with 6m and 8m gun
W021696	Chili	5,9 / 2,5	6	1.2	Al, Ss, (Fe)	W	GX-S with L250mm neck / More wire feed disturbance may occur when welded Al with 6m and 8m gun
W021697	Chili	5,9 / 2,5	8	1.2	Al, Ss, (Fe)	W	GX-S with L250mm neck / More wire feed disturbance may occur when welded Al with 6m and 8m gun
W021063	Steel	5,6 / 1,8	6	1.0-1.2	Fe	G / W	GX-S / Chili is strongly recommended for 6m and 8m S-guns
W021065	Steel	5,8 / 2,4	6	1.2-1.6	Fe	G / W	GX-S / Chili is strongly recommended for 6m and 8m S-guns
W021071	Steel	5,6 / 1,8	8	1.0-1.2	Fe	G / W	GX-S / Chili is strongly recommended for 6m and 8m S-guns

WIRE LINERS FOR FLEXLITE MIG GUNS STANDARD LENGTH (SERIES 3, 5 AND 8)

Ordering code	Liner type	Liner ø OD/ID	Length, m	Wire Ø, mm	Material	Cooling	Note
4307650	Steel	4,7 / 1,5	3	0.6-1.0	Fe	G	MinarcMig
4307660	Chili	4,7 / 1,5	3	0.6-1.0	Ss, Al	G	MinarcMig
W013621	Steel	5,3 / 1,4	3.5	0.6-0.8	Fe, FeFc, FeMc	G / W	GX, GF (Euro Connector)
W013628	Steel	5,3 / 1,8	3.5	0.9-1.2	Fe, FeFc, FeMc	G / W	GX, GF (Euro Connector)
W013630	Steel	5,3 / 2,4	3.5	1.2-1.6	Fe, FeFc, FeMc	G / W	GX, GF (Euro Connector)
W013631	Steel	5,3 / 1,4	5	0.6-0.8	Fe, FeFc, FeMc	G / W	GX, GF (Euro Connector)
W013632	Steel	5,3 / 1,8	5	0.9-1.2	Fe, FeFc, FeMc	G / W	GX, GF (Euro Connector)
W013634	Steel	5,3 / 2,4	5	1.2-1.6	Fe, FeFc, FeMc	G / W	GX, GF (Euro Connector)
W022933	Steel	5,3 / 1,4	3.5	0.6-0.8	Fe, FeFc, FeMc	G / W	GX8-W (Kemppi Connector)
W022931	Steel	5,3 / 1,8	3.5	0.9-1.2	Fe, FeFc, FeMc	G / W	GX8-W (Kemppi Connector)
W022926	Steel	5,3 / 2,4	3.5	1.2-1.6	Fe, FeFc, FeMc	G / W	GX8-W (Kemppi Connector)
W022932	Steel	5,3 / 1,4	5	0.6-0.8	Fe, FeFc, FeMc	G / W	GX8-W (Kemppi Connector)
W022927	Steel	5,3 / 1,8	5	0.9-1.2	Fe, FeFc, FeMc	G / W	GX8-W (Kemppi Connector)
W022919	Steel	5,3 / 2,4	5	1.2-1.6	Fe, FeFc, FeMc	G / W	GX8-W (Kemppi Connector)
W013609	Chili	4,7 / 1,3	3.5	0.6-0.8	Ss, Al, (Fe)	G/W	GX, GF, GC
W013610	Chili	4,7 / 1,5	3.5	0.8-1.0	Ss, Al, (Fe)	G/W	GX, GF, GC
W013611	Chili	4,7 / 2,0	3.5	1.0-1.2	Ss, Al, (Fe)	G/W	GX, GF, GC
W013638	Chili	4,7 / 2,5	3.5	1.2-1.6	Ss, Al, (Fe)	G/W	GX, GF, GC
W013613	Chili	4,7 / 1,3	5	0.6-0.8	Ss, Al, (Fe)	G/W	GX, GF, GC
W013614	Chili	4,7 / 1,5	5	0.8-1.0	Ss, Al, (Fe)	G/W	GX, GF, GC
W013615	Chili	4,7 / 2,0	5	1.0-1.2	Ss, Al, (Fe)	G/W	GX, GF, GC
W013642	Chili	4,7 / 2,5	5	1.2-1.6	Ss, Al, (Fe)	G/W	GX, GF, GC
4188573	Steel	4,7 / 1,5	3.5	0.6-0.8	Fe, FeFc, FeMc	G	GC (Also used in FE guns)
W006453	Steel	4,7 / 2,0	3.5	0.9-1.2	Fe, FeFc, FeMc	G	GC (Also used in FE guns)
4188576	Steel	4,7 / 1,5	5	0.6-0.8	Fe, FeFc, FeMc	G	GC (Also used in FE guns)
W006454	Steel	4,7 / 2,0	5	0.9-1.2	Fe, FeFc, FeMc	G	GC (Also used in FE guns)
W014831	Chili	6,6 / 3,6	5	2.0-2.4	Al	W	GX605W / GX608W
W012614	Steel	5,8 / 2,4	5	1.2-1.6	Fe, FeFc, FeMc	W	GX605W / GX608W
W013652	Steel	7,5 / 3,5	5	2.0-2.4	Fe, FeFc, FeMc	W	GX605W / GX608W

WIRE LINERS FOR FLEXLITE MIG GUN MULTINECK MODELS (SERIES 5 AND 8)

Ordering code	Liner type	Liner ø OD/ID	Length, m	Wire Ø, mm	Material	Cooling	Note
W012361	Steel	5,6 / 1,8	3.5	0.9-1.2	Fe, FeFc, FeMc	G	GX-MN
W012363	Steel	5,8 / 2,4	3.5	1.2-1.6	Fe, FeFc, FeMc	G	GX-MN
W012362	Steel	5,6 / 1,8	5	0.9-1.2	Fe, FeFc, FeMc	G	GX-MN
W012364	Steel	5,8 / 2,4	5	1.2-1.6	Fe, FeFc, FeMc	G	GX-MN
W012355	Chili	5,9 / 1,5	3.5	0.6-1.0	Al, Ss, (Fe)	G	GX-MN
W012356	Chili	5,9 / 2,0	3.5	1.0-1.2	Al, Ss, (Fe)	G	GX-MN
W012357	Chili	5,9 / 2,5	3.5	1.2-1.6	Al, Ss, (Fe)	G	GX-MN
W012351	Chili	5,9 / 1,5	5	0.6-1.0	Al, Ss, (Fe)	G	GX-MN
W012352	Chili	5,9 / 2,0	5	1.0-1.2	Al, Ss, (Fe)	G	GX-MN
W012353	Chili	5,9 / 2,5	5	1.2-1.6	Al, Ss, (Fe)	G	GX-MN



Wire guide tubes

Kempfi wire guide tubes facilitate installation and tightening of the wire liner into its correct position.

WIRE GUIDE TUBES FOR EURO CONNECTOR MIG HUNS (SERIES 3 AND 5)

Ordering code	Description	Tube type	Wire Ø, mm	Material	Cooling	Note
SP022778	LONG NUT EURO 1-PIECE SMALL	Brass	-	Al, Ss, Fe	G / W	
SP022872	LONG NUT EURO 1-PIECE LARGE	Brass	-	Al, Ss, Fe	G / W	600W, MN, S

WIRE GUIDE TUBES FOR KEMPFI CONNECTOR MIG GUNS (SERIES 8)

Ordering code	Tube type	Wire Ø, mm	Material	Cooling	Note
SP013595	Plastic	0.6	Al, Ss		
SP013596	Plastic	0.8-0.9	Al, Ss	W	
SP013597	Plastic	1.0	Al, Ss	W	
SP013598	Plastic	1.2	Al, Ss	W	
SP013599	Plastic	1.4	Al, Ss	W	
SP013600	Plastic	1.6	Al, Ss	W	
SP013751	Metal	0.8-0.9	Fe	W	
SP013752	Metal	1.0	Fe	W	
SP013753	Metal	1.2	Fe	W	
SP013754	Metal	1.4	Fe	W	
SP013755	Metal	1.4-1.6	Fe	W	
SP009276	Plastic	0.6	Al, Ss	G	
SP011867	Plastic	0.8-0.9	Al, Ss	G	
SP011868	Plastic	1.0	Al, Ss	G	
SP011869	Plastic	1.2	Al, Ss	G	420-W-8m
SP011870	Plastic	1.4	Al, Ss	G	420-W-8m
SP011871	Plastic	1.6	Al, Ss	G	420-W-8m
SP011872	Plastic	2.0	Al, Ss	G	
SP011873	Plastic	2.4	Al, Ss	G	
SP011886	Metal	0.6	Fe	G	
SP011887	Metal	0.8-0.9	Fe	G	
SP011888	Metal	1.0	Fe	G	
SP011889	Metal	1.2	Fe	G	
SP011890	Metal	1.4	Fe	G	
SP011891	Metal	1.4-1.6	Fe	G	
SP011892	Metal	2.0	Fe	G	600-W
SP011893	Metal	2.4	Fe	G	600-W

MIG consumable kits

The Flexlite MIG Consumable Kits include the most common contact tips and gas nozzles with either M6 or M10 threads. The consumables are packaged within a sturdy, reusable case, which can be used to store all the essential consumables for Flexlite MIG welding guns. The label on the cover shows the product codes, which makes it easier to order more consumables.



These consumable kits are an easy way for the user to get standard consumables for most welding applications or test the suitability of different materials or contact tip clearance sizes.

By selecting Kemppi MIG consumables you will receive the durability and performance that you need.

MG000601	Consumable KIT Basic STD M6	Qty	MG001005	Consumable KIT HD LIFE+ M10, wire 1.0, nozzle Ø25	Qty
CT08C1SD003	CONTACT TIP 0.8 C1 STD M6	10	CT10C1LP002	CONTACT TIP 1.0 C1 LIFE+ M10	5
CT10C1SD003	CONTACT TIP 1.0 C1 STD M6	5	CT10C2LP002	CONTACT TIP 1.0 C2 LIFE+ M10	5
9591079	INSULATING RING NECK	2	CT10C3LP002	CONTACT TIP 1.0 C3 LIFE+ M10	5
958010101	GAS NOZZLE WITH INSULATOR, PMT25	2	W021179	GAS NOZZLE HD, THREAD, L61 / OD25 / D16	2
9580173	CONTACT TIP ADAPTER MT18, 25	2	W013203	CONTACT TIP ADAPTER M10X1 INSULATED	2
MG001001	Consumable KIT Basic STD M10, wire 1.0, nozzle Ø25	Qty	MG001006	Consumable KIT HD LIFE+ M10, wire 1.0, nozzle Ø28	Qty
CT10C1SD001	CONTACT TIP 1.0 C1 STD M10	5	CT10C1LP002	CONTACT TIP 1.0 C1 LIFE+ M10	5
CT10C2SD001	CONTACT TIP 1.0 C2 STD M10	5	CT10C2LP002	CONTACT TIP 1.0 C2 LIFE+ M10	5
CT10C3SD001	CONTACT TIP 1.0 C3 STD M10	5	CT10C3LP002	CONTACT TIP 1.0 C3 LIFE+ M10	5
W013930	GAS NOZZLE THREAD L=61 / Ø16 / OD25	2	W021186	GAS NOZZLE HD, THREAD, L64 / OD28 / D17	2
W013203	CONTACT TIP ADAPTER M10X1 INSULATED	2	W013203	CONTACT TIP ADAPTER M10X1 INSULATED	2
MG001002	Consumable KIT Basic STD M10, wire 1.0, nozzle Ø28	Qty	MG001007	Consumable KIT HD LIFE+ M10, wire 1.2, nozzle Ø25	Qty
CT10C1SD001	CONTACT TIP 1.0 C1 STD M10	5	CT12C1LP002	CONTACT TIP 1.2 C1 LIFE+ M10	5
CT10C2SD001	CONTACT TIP 1.0 C2 STD M10	5	CT12C2LP002	CONTACT TIP 1.2 C2 LIFE+ M10	5
CT10C3SD001	CONTACT TIP 1.0 C3 STD M10	5	CT12C3LP002	CONTACT TIP 1.2 C3 LIFE+ M10	5
W013931	GAS NOZZLE THREAD L=64 / Ø17 / OD28	2	W021179	GAS NOZZLE HD, THREAD, L61 / OD25 / D16	2
W013203	CONTACT TIP ADAPTER M10X1 INSULATED	2	W013203	CONTACT TIP ADAPTER M10X1 INSULATED	2
MG001003	Consumable KIT Basic STD M10, wire 1.2, nozzle Ø25	Qty	MG001008	Consumable KIT HD LIFE+ M10, wire 1.2, nozzle Ø28	Qty
CT12C1SD001	CONTACT TIP 1.2 C1 STD M10	5	CT12C1LP002	CONTACT TIP 1.2 C1 LIFE+ M10	5
CT12C2SD001	CONTACT TIP 1.2 C2 STD M10	5	CT12C2LP002	CONTACT TIP 1.2 C2 LIFE+ M10	5
CT12C3SD001	CONTACT TIP 1.2 C3 STD M10	5	CT12C3LP002	CONTACT TIP 1.2 C3 LIFE+ M10	5
W013930	GAS NOZZLE THREAD L=61 / Ø16 / OD25	2	W021186	GAS NOZZLE HD, THREAD, L64 / OD28 / D17	2
W013203	CONTACT TIP ADAPTER M10X1 INSULATED	2	W013203	CONTACT TIP ADAPTER M10X1 INSULATED	2
MG001004	Consumable KIT Basic STD M10, wire 1.2, nozzle Ø28	Qty	MG000602	Consumable KIT Basic STD M6 AU	Qty
CT12C1SD001	CONTACT TIP 1.2 C1 STD M10	5	CT08C1SD003	CONTACT TIP 0.8 C1 STD M6	5
CT12C2SD001	CONTACT TIP 1.2 C2 STD M10	5	CT09C1SD003	CONTACT TIP 0.9 C1 STD M6	5
CT12C3SD001	CONTACT TIP 1.2 C3 STD M10	5	9591079	INSULATING RING NECK	1
W013931	GAS NOZZLE THREAD L=64 / Ø17 / OD28	2	958010101	GAS NOZZLE WITH INSULATOR	1
W013203	CONTACT TIP ADAPTER M10X1 INSULATED	2	9580173	CONTACT TIP ADAPTER	1

MIG consumable kits

MG001009	Consumable KIT Basic STD M10, nozzle Ø25 AU	Qty
CT09C1SD001	CONTACT TIP 0.9 C1 STD M10	5
CT12C1SD001	CONTACT TIP 1.2 C1 STD M10	5
CT12C3SD001	CONTACT TIP 1.2 C3 STD M10	5
W013930	GAS NOZZLE THREAD L=61 / Ø16 / OD25	1
W013203	CONTACT TIP ADAPTER M10X1 INSULATED	1

MG001010	Consumable KIT Basic STD M10, nozzle Ø28 AU	Qty
CT09C1SD001	CONTACT TIP 0.9 C1 STD M10	5
CT12C1SD001	CONTACT TIP 1.2 C1 STD M10	5
CT12C3SD001	CONTACT TIP 1.2 C3 STD M10	5
W013931	GAS NOZZLE THREAD L=64 / Ø17 / OD28	1
W013203	CONTACT TIP ADAPTER M10X1 INSULATED	1

MG001011	Consumable KIT Basic STD M10, nozzle Ø22	Qty
CT08C1SD001	CONTACT TIP 0.8 C1 STD M10	5
CT10C1SD001	CONTACT TIP 1.0 C1 STD M10	5
CT12C1SD001	CONTACT TIP 1.2 C1 STD M10	5
W014452	GAS NOZZLE THREAD, L57 / OD22 / D14	2
W013203	CONTACT TIP ADAPTER M10X1 INSULATED	2

MG001012	Consumable KIT HD LIFE+ M10, wire 1.0, nozzle Ø22	Qty
CT10C1LP002	CONTACT TIP 1.0 C1 LIFE+ M10	5
CT10C2LP002	CONTACT TIP 1.0 C2 LIFE+ M10	5
CT10C3LP002	CONTACT TIP 1.0 C3 LIFE+ M10	5
W021564	GAS NOZZLE, HD THREAD, L57 / OD22 / D14	2
W013203	CONTACT TIP ADAPTER M10X1 INSULATED	2

MG001013	Consumable KIT HD LIFE+ M10, wire 1.2, nozzle Ø22	Qty
CT12C1LP002	CONTACT TIP 1.2 C1 LIFE+ M10	5
CT12C2LP002	CONTACT TIP 1.2 C2 LIFE+ M10	5
CT12C3LP002	CONTACT TIP 1.2 C3 LIFE+ M10	5
W021564	GAS NOZZLE, HD THREAD, L57 / OD22 / D14	2
W013203	CONTACT TIP ADAPTER M10X1 INSULATED	2



WELTAS
EM 12017/12001 + A.1. 2002
TYPE: B
10-1050
10-1050
10-1050

FLEXLITE TX

Ignite your passion for welding

Flexlite TX product series contains welding torches to be used in TIG welding process. There are Flexlite TX models available in two series: 3 and 5. Each series is designed to serve specific welding needs. All Flexlite TX models enjoy the Flexlite features for user comfort, welding efficiency and extended consumable part life.



Visit website:

> <https://kemp.cc/flexlite-tx/com-en>



reddot winner 2020
industrial design



Flexlite TX torches for TIG welding

Flexlite TX welding torches for TIG welding increase user comfort and lower welder fatigue. Silicone rubber material gives a firm grip, and the innovative design reduces wrist loading, allowing you to concentrate on challenging tasks to achieve the perfect weld.

Flexlite TX torches are available in alternative power classes and lengths, including different neck versions: fixed, flexible and S-shaped.



EXCELLENT ERGONOMICS

Flexlite TX torches feature unique and innovative handle flexibility, moving the moment of load away from the welder's wrist, reducing apparent weight and lowering fatigue.



USABILITY MEANS EFFICIENCY

Compact neck designs include rigid, flexible and S-shaped rotating neck designs, offering superb cooling performance and good access to challenging joint designs.



QUALITY IS MORE THAN MEETS THE EYE

Kemppi consumables and accessories support both welding quality and productivity.

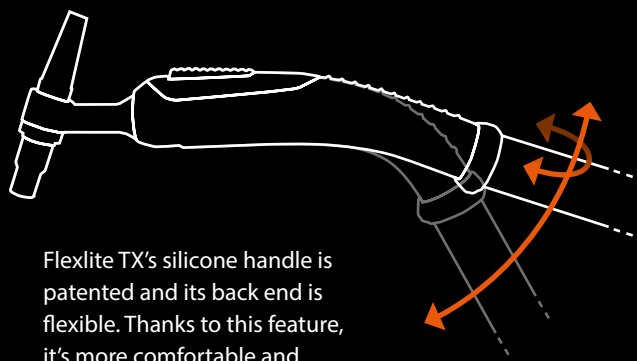

Flexlite TX's silicone handle is patented and its back end is flexible. Thanks to this feature, it's more comfortable and ergonomic in the welder's hand.

Materials selection elevates usability

The Flexlite TX silicone rubber handles are shaped to the hand. They consider both right and left-handed welders and alternative holding positions. Combined with cables set flexibility and leather sheathing protection, Flexlite TX materials selection elevates usability to maximize welding comfort and practical durability.

Fixed neck, flexible neck and S-shaped rotating neck. Flexlite TX torches are designed to provide best welding ergonomics in all welding positions.





QUALITY IS MORE THAN MEETS THE EYE!

Shielding gas flow has a significant effect on weld quality. Normally shielding gas flow is invisible, but this simulation demonstrates how torch design and consumable parts affect gas turbulence and effective shielding gas coverage.

Kemppi gas lenses include many high-quality gas diffuser mesh layers. This structure provides the best performance by improving the laminar flow compared to other conventional designs.

Kemppi consumables support welding quality and productivity

Consumables represent only a small portion of the total costs in TIG welding, but from the quality point of view they play an important role.

Kemppi offers all consumables for your TIG welding applications. Manufactured using the best processes and materials, Kemppi consumables help you create top quality TIG welds. Kemppi consumables and accessories are designed especially to suit your Flexlite torches. To get the best quality and cost-effectiveness for your welding, equip your Flexlite torch with Kemppi consumables.



The picture on the right shows a highly turbulent flow, offering poor shielding and elevated gas consumption.

The picture on the left defines a torch fitted with a Kemppi gas lens kit, creating a smooth laminar gas flow, excellent weld pool shielding and economic gas usage.

Welding comfort and

KEMPPI CONSUMABLES

Manufactured using the best processes and materials, Kemppi consumables support your welding productivity and help you create top quality TIG welds.

GOOD ACCESS

Neck designs include rigid, flexible and S-shaped rotating necks, offering superb cooling performance and good access to challenging joint designs.

FIRM GRIP

Silicone rubber material gives a firm grip, and the innovative design reduces wrist loading, allowing you to concentrate on challenging tasks to achieve the perfect weld.

EASY ACCESS TO INFORMATION

The QR code takes you directly to relevant ordering codes, consumables, product documents and Kemppi contacts.



practical durability

TRIGGER OPTIONS

Available with or without a trigger switch. An optional switch extension makes the trigger control more accurate when holding the torch close to the welding head.

REMOTE CONTROLS

Flexlite TX torches offer alternative on-torch remote controls, which allow accurate and immediate welding current adjustment at distance. Remote controls are available for Series 5 models only.

SHAPED TO THE HAND

The Flexlite TX handles are shaped to the hand. They consider both right and left-handed welders and alternative holding positions.

DURABILITY

The cable set flexibility and leather sheathing protection elevates usability to maximize welding comfort and practical durability.

Flexlite TX models

SELECT SUITABLE TORCH ACCORDING TO THE SERIES

Kemppi's Flexlite TX welding torches are divided into two series: 3 and 5. The difference between them is the type of connectors in control cable and cooling water hoses as shown in the pictures below. The Series 3 also includes models with Euro connector and DIX connector. DIX connector models have a shielding gas valve in the torch body.



Series 3 models have screw-in connectors in water hoses and a 4-pin control cable connector.



Series 5 models have snap connectors in water hoses and a 7-pin control cable connector.



Euro connector



DIX connector

Welding capacity, physical size and reach are primary considerations when selecting the torch for your application. Thermal efficiency, consumables design and lifetime, are values that will improve your welding satisfaction and reduce overall costs.

Flexlite products offer a wide range of models, so you can be sure to select the capacity, size, and length, to match your application. Be it road vehicles or aerospace, Flexlite ignites your passion for welding.



TX135GF
TX133GF



TX165GF
TX163GF



TX165GS
TX163GS



TX163GVD9
TX223GVD13



TX165G
TX225G
TX223G
TX223GE



TX225GS
TX223GS
TX225GF



TX255WS
TX253WS
TX253WSE



TX305WF
TX303WF
TX305W



TX355W
TX353W
TX353WE



TX455W



TX225GFL



TX255WFL

Technical data

Flexlite TX (all models)		135GF 133GF	165GF 163GF	165GS 163GS	165G	163GVD9	225G 223G	225GF	225GS 223GS 225GFL	223GE	223GVD13	255WS 253WS 255WFL	253WSE	305WF 303WF	305W	355W 353W	353WSE	455W
Type of cooling		Gas	Gas	Gas	Gas	Gas	Gas	Gas	Gas	Gas	Gas	Water	Water	Water	Water	Water	Water	Water
Coolant flow rate	l/min	-	-	-	-	-	-	-	-	-	-	1	1	1	1	1	1	1
Coolant pressure (min)	MPa	-	-	-	-	-	-	-	-	-	-	0.1	0.1	0.1	0.1	0.1	0.1	0,1
Coolant pressure (max)	MPa	-	-	-	-	-	-	-	-	-	-	0.5	0.5	0.5	0.5	0.5	0.5	0,5
Arc striking voltage	kV	10	10	10	10	10	10	10	10	-	10	10	-	10	10	10	10	10
Load capacity @ 40 % (Argon)	A	130	160	160	160	160	220	220	220	220	220	250	250	300	300	350	350	450
Load capacity @ 100 % (Argon)	A	-	-	-	-	-	-	-	-	-	-	200	200	200	200	250	250	320
Operating temperature range	°C	-10...+40																
Storage temperature range	°C	-40...+60																
Minimum cooling power at 1.0 l/min	kW	-	-	-	-	-	-	-	-	-	-	1.0 kW	1.0 kW	1.0 kW	1.0 kW	1.0 kW	1.0 kW	1.0 kW
Neck type:																		
Flexible		●	●					●							●			
Rotating				●					●			●	●					
70° angle					●	●	●			●	●				●	●	●	●
Torch head type		Small	Large	Small	Large	Large	Large	Large	Large	Large	Large	Small	Small	Small	Small	Large	Large	Large

SERIES 3

Flexlite TX (Series 3 models)		133GF	163GF	163GS	163GVD9	223G	223GS	223GE	223GVD13
Type of connection	Current-gas	G1/4	G1/4	G1/4	DIX 9 mm	G1/4	G1/4	Euro connector	DIX 13 mm
	Control	4-pin	4-pin	4-pin	-	4-pin	4-pin	-	-
	Coolant	-	-	-	-	-	-	-	-
Electrode diameters	mm	1.0...2.4	1.0...4.0	1.0...2.4	1.0...4.0	1.0...4.0	1.0...4.0	1.0...4.0	1.0...4.0
Remote control		-	-	-	-	-	-	-	-

Flexlite TX (Series 3 models)		253WS	253WSE	303WF	353W	353WSE
Type of connection	Current-gas		Euro connector			Euro connector
	Control	4-pin	-	4-pin	4-pin	-
	Coolant	G1/4 & G3/8	Snap connector	G1/4 & G3/8	G1/4 & G3/8	Snap connector
Electrode diameters	mm	1.0...4.0	1.0...4.0	1.0...2.4	1.0...4.0	1.0...4.0
Remote control		-	-	-	-	-

These equipment comply with standard IEC 60974-7.

SERIES 5

Flexlite TX (Series 5 models)		135GF	165GF	165GS	165G	225G 225GF	225GS 225GFL	255WS 255WFL	305WF 305W	355W	455W
Type of connection	Current-gas	G1/4	G1/4	G1/4	G1/4	G1/4	G1/4	G1/4	G1/4	G1/4	G1/4
	Control	7-pin	7-pin	7-pin	7-pin	7-pin	7-pin	7-pin	7-pin	7-pin	7-pin
	Coolant	-	-	-	-	-	-	Snap connector	Snap connector	Snap connector	Quick connector
Electrode diameters	mm	1.0...2.4	1.0...4.0	1.0...2.4	1.0...4.0	1.0...4.0	1.0...4.0	1.0...2.4	1.0...2.4	1.0...4.0	1.0...4.8
Remote control		Optional	Optional	Optional	Optional	Optional	Optional	Optional	Optional	Optional	Optional

Flexlite TX models 163GVD9 and 223GVD13 are equipped with a DIX connector and a manual gas valve to regulate the shielding gas flow, ensuring basic TIG welding tasks are easily completed. Use with MMA power sources for scratch and TouchArc TIG ignition.

Torch bodies compatibility table (gas) 			Head size	TX133GF TX135GF TX135GFN	TX163GF TX165GF TX165GFN	TX165G	TX163GS TX165GS TX165GSN	TX223G TX225G TX225GN	TX223GS TX225GS	TX223GE	TX163GV TX223GV
SP013377	TORCH BODY FLEX G S, TX		S	●	○	○	○	○	○	○	
SP013386	TORCH BODY FLEX G L, TX		L	○	●	○	○	○	○	○	
SP021160	TORCH BODY RIGID G S, TX		S	○	○	○	○	○	○	○	
SP013362	TORCH BODY RIGID G L, TX		L	○	○	●	○	●	○	●	
SP016429	TORCH BODY RIGID V G L, TX		L								●
SP013394 *	TORCH BODY ROTATING G, TX		S/L	○	○	○	●	○	●	○	
SP801064 *	TORCH BODY ROTATING HEAD S, TX		S	○	○	○	●	○	○	○	
SP013404 *	TORCH BODY S-NECK HEAD L, TX		L	○	○	○	○	○	●	○	
SP016559*	TORCH BODY S-LOCK G, TX		S/L	○	○	○	○	○	○	○	
SP016808*	TORCH BODY S-LOCK HEAD S, TX		S	○	○	○	○	○	○	○	
SP016810*	TORCH BODY S-LOCK HEAD L, TX		L	○	○	○	○	○	○	○	
SP021924*	TORCH BODY FLEX-LOCK G, TX		S/L	○	○	○	○	○	○	○	
SP200140*	TORCH BODY HEAD FLEX-LOCK S, TX		S	○	○	○	○	○	○	○	
SP200139*	TORCH BODY HEAD FLEX-LOCK L, TX		L	○	○	○	○	○	○	○	

* Cannot be used separately

● = Standard delivery ○ = Accessory

The name of a Flexlite torch tells its properties and use

Model series name

Power rating

Kemppi series:







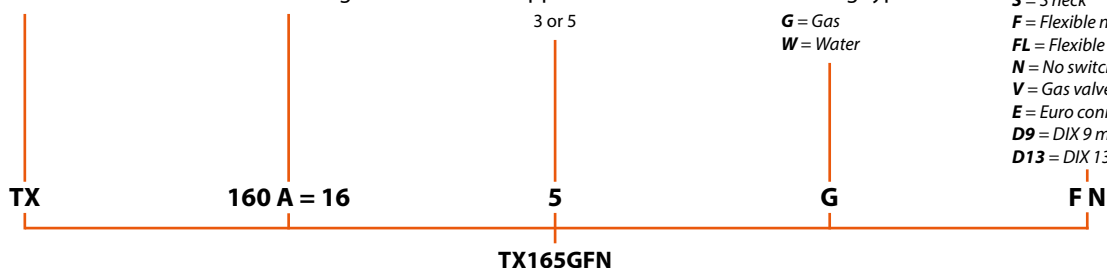







Cooling type:

Technical features:

S = S neck
F = Flexible neck
FL = Flexible locking
N = No switch
V = Gas valve
E = Euro connector
D9 = DIX 9 mm
D13 = DIX 13 mm



Technical data

Torch bodies compatibility table (water) 			Head size	TX253WS	TX255WS	TX255WSN	TX303WF	TX305WF	TX305WFN	TX353W	TX355W	TX355WN	TX253WSE	TX353WSE	TX455W
SP014126	TORCH BODY FLEX W S, TX		S	○	○	○	●	○	○	○	○	○	○	○	○
SP021164	TORXH BODY RIGID W S, TX		S	○	○	○	○	○	○	○	○	○	○	○	○
SP013423	TORCH BODY RIGID W L, TX		L	○	○	○	○	○	○	●	○	○	○	○	○
SP017031	TORCH BODY RIGID LONG W L, TX		L	○	○	○	○	○	○	○	○	○	○	○	●
SP014575*	TORCH BODY ROTATING W, TX		S/L	●	○	○	○	○	○	○	○	○	○	○	○
SP801064*	TORCH BODY ROTATING HEAD S, TX		S	●	○	○	○	○	○	○	○	○	○	○	○
SP013404*	TORCH BODY S-NECK HEAD L, TX		L	○	○	○	○	○	○	○	○	○	○	○	○
SP016557*	TORCH BODY S-LOCK W, TX		S/L	○	○	○	○	○	○	○	○	○	○	○	○
SP016808*	TORCH BODY S-LOCK HEAD S, TX		S	○	○	○	○	○	○	○	○	○	○	○	○
SP016810*	TORCH BODY S-LOCK HEAD L, TX		L	○	○	○	○	○	○	○	○	○	○	○	○
SP021923*	TORCH BODY FLEX-LOCK W, TX		S/L	○	○	○	○	○	○	○	○	○	○	○	○
SP200140*	TORCH BODY HEAD FLEX-LOCK S, TX		S	○	○	○	○	○	○	○	○	○	○	○	○
SP200139*	TORCH BODY HEAD FLEX-LOCK L, TX		L	○	○	○	○	○	○	○	○	○	○	○	○

* Cannot be used separately

● = Standard delivery ○ = Accessory

The name of a Flexlite torch tells its properties and use

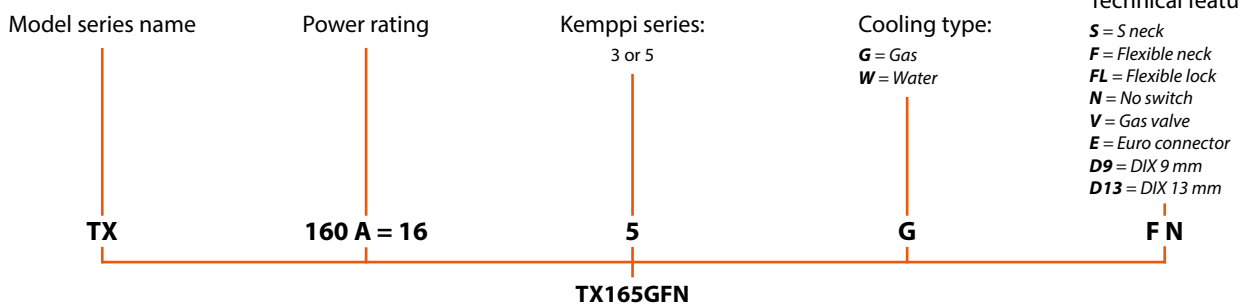





FLEXLITE

Flexlite TX

Flexlite TX product range offers optional accessories for your torch to make it a perfect tool for your welding. Optimize your torch and make your TIG welding more efficient and convenient with accessories.

Trigger switch options

Available with or without a trigger switch, Flexlite TX range also includes an optional switch extension to replace the regular switch. It makes the trigger control more accurate when holding the torch close to the welding head.



Regular switch



Switch extension



No switch

Remote control options

Whatever your preference and machine type, Flexlite TX TIG torches offer an alternative on-torch remote control, which allows accurate and immediate welding current adjustment at a distance. Select either rocker or roller type of switch. Remote controls can be used only in Series 5 Flexlite TX torches.



Torch remote control R10 (roller model)



Torch remote control R20 (rocker model)

Consumables

Small torch body, standard consumables



1. Gas nozzle		mm			
No.	Ordering code	a	b	c	d
4	7990760	14.5	10	6.5	30
5	7990761*	14.5	11	8	30
6	7990762	14.5	14.5	10	30
7	7990763	14.5	14.5	11	30

2. Collet body	
ø 1.0	7990660
ø 1.6	7990661
ø 2.4	7990662 *

3a. Collet	
ø 1.0	7990635
ø 1.6	7990636
ø 2.4	7990637 *

3b. Reverse collet	
ø 1.0	7990640
ø 1.6	7990641
ø 2.4	7990642

4. Torch body

See suitability from torch bodies compatibility table on page 85-86.

5. O-ring	
SP7990790	

6. Back cap		Length (mm)
Small	7990730	18
Medium	7990734 *	48
Long	7990740	145

Electrode		
Grey	ø 1.0	9873531
	ø 1.6	9873532
	ø 2.4	9873533 *
White	ø 1.0	9873520
	ø 1.6	9873521
	ø 2.4	9873522
Length of all electrodes 175 mm		

* Delivery equipment is for ø 2.4 mm electrode. Lens equipment is delivered as an accessory. The above mentioned dimensions are directive.

Electrode sharpened 22,5 deg		
Grey	ø 2.4	9873536
Length of all electrodes 85 mm		

Consumables

Large torch body, standard consumables

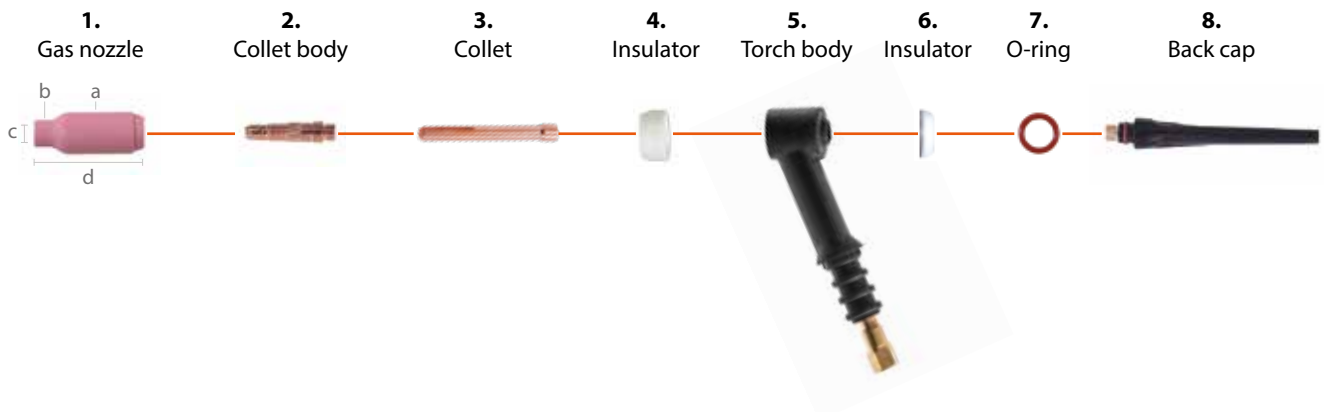

1. Gas nozzle		mm			
No.	Ordering code	a	b	c	d
4	7990766	18	11.5	6.5	47.5
5	7990770	18	12.5	8	47.5
6	7990771 *	18	14.5	9.5	47.5
7	7990772	18	16	11	47.5
8	7990773	18	18	12.5	47.5
10	7990775	21	21	16	47.5
12	7990776	24	24	19	47.5

2. Collet body	
ø 1.6	7990681
ø 2.4	7990682 *
ø 3.2	7990683
ø 4.0	7990684

3. Collet	
ø 1.6	9876867
ø 2.4	9876868 *
ø 3.2	9876869
ø 4.0	9876870
ø 4.0	SP021459 (HD)

4. Insulator	
SP9580266	

5. Torch body
See suitability from torch bodies compatibility table on page 85-86.

6. Insulator	
SP9580267	

7. O-ring	
SP7990791	

8. Back cap		Length (mm)
Small	7990731	26
Medium	7990735	58
Long	7990741 *	120

Electrode		
Grey	ø 1.6	9873532
	ø 2.4	9873533 *
	ø 3.2	9873534
	ø 4.0	9873535
White	ø 1.6	9873521
	ø 2.4	9873522
	ø 3.2	9873523
Green	ø 4.0	9873524
	ø 4.0	9873505
Length of all electrodes 175 mm		

* Delivery equipment is for ø 2.4 mm electrode. Lens equipment is delivered as an accessory. The above mentioned dimensions are directive.

Electrode sharpened 22,5 deg		
Grey	ø 2.4	9873536
Grey	ø 3.2	9873537
Length of all electrodes 85 mm		

Consumables

Small torch body, lens consumables

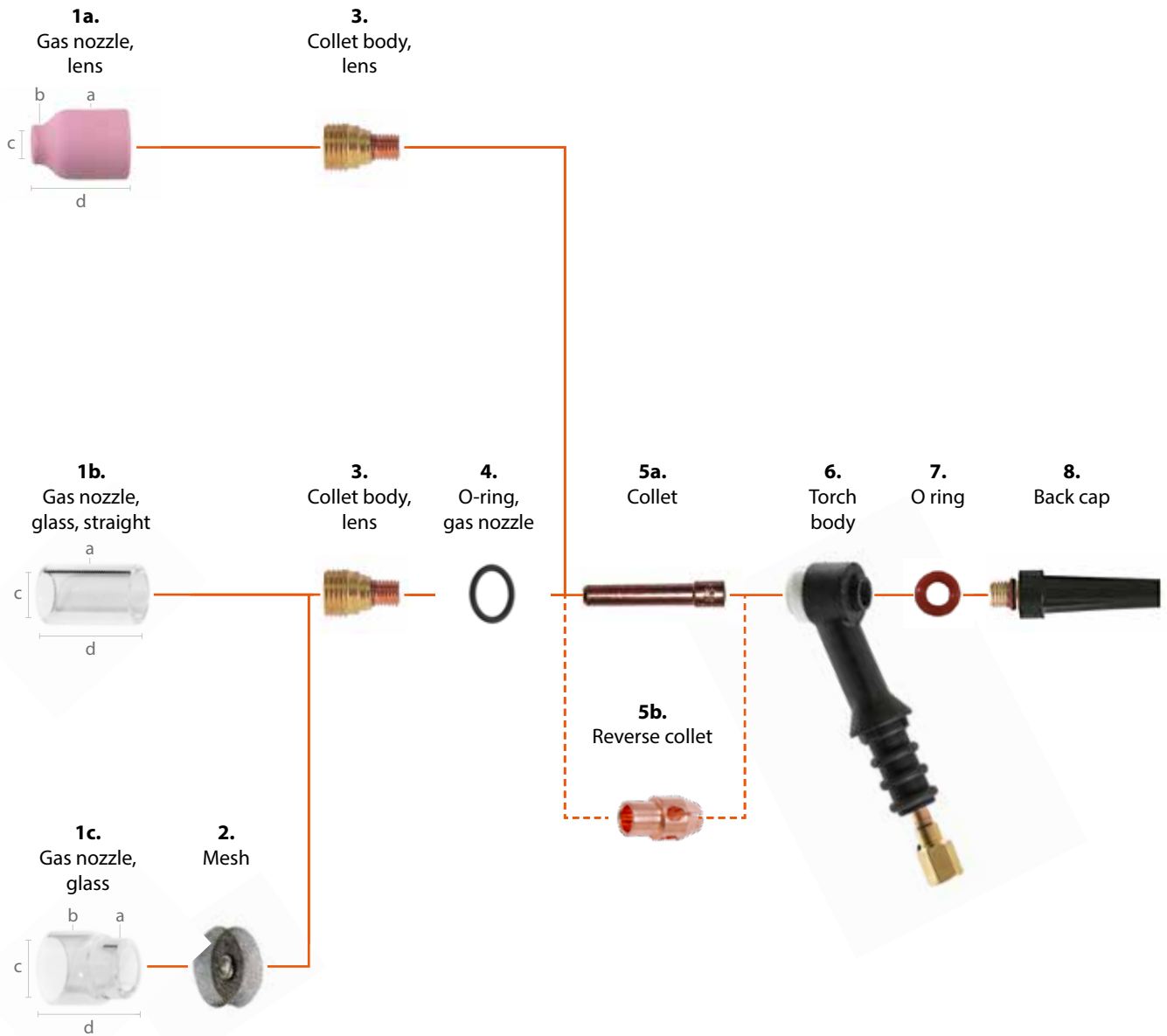

1a. Gas nozzle, lens		mm			
No.	Ordering code	a	b	c	d
4	7990779	18.5	10.5	7	25.5
5	7990780	18.5	12	8	25.5
6	7990781	18.5	13.5	9.5	25.5
7	7990782	18.5	15	11	25.5
8	SP016562	18.5	16.5	12.5	25.5

1b. Gas nozzle, glass, straight		mm		
	Ordering code	a	c	d
Straight	SP015847	19.9	14.8	32.5

1c. Gas nozzle, glass		mm			
	Ordering code	a	b	c	d
15/20 mm	SP015848	20.2	25.3	21	28.3

2. Mesh	
	SP015851

3. Collet body, lens	
ø 1.0	7990700
ø 1.6	7990701
ø 2.4	7990702

4. O-ring, gas nozzle, glass	
	SP009746

5a. Collet	
ø 1.0	7990635
ø 1.6	7990636
ø 2.4	7990637

5b. Reverse collet	
ø 1.0	7990640
ø 1.6	7990641
ø 2.4	7990642

6. Torch body

See suitability from torch bodies compatibility table on page 85.

7. O-ring

	SP7990790
--	-----------

8. Back cap

		Length (mm)
Small	7990730	18
Medium	7990734	48
Long	7990740	145

Electrode

Grey	ø 1.0	9873531
	ø 1.6	9873532
	ø 2.4	9873533
White	ø 1.0	9873520
	ø 1.6	9873521
	ø 2.4	9873522
Length of all electrodes 175 mm		

Electrode sharpened 22,5 deg

Grey	ø 2.4	9873536
Length of all electrodes 85 mm		

Consumables

Large torch body, lens consumables

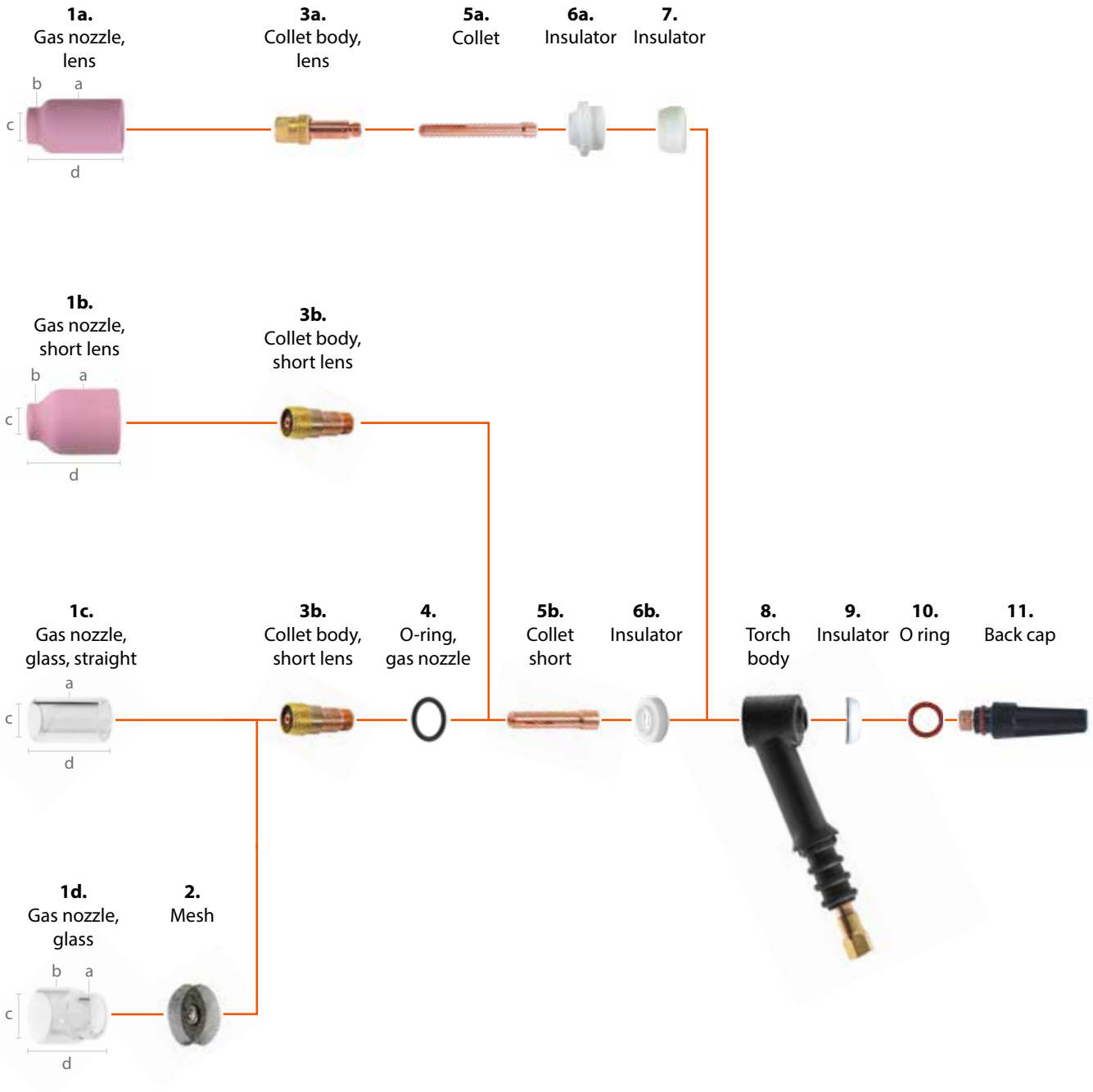

Flexlite TX

1a. Gas nozzle, lens		mm			
No.	Ordering code	a	b	c	d
5	7990783	25	12.5	7.5	42
6	7990784	25	14	9	42
7	7990785	25	15.5	11	42
8	7990786	25	16.5	12	42
11	7990787	25	22	17	42
	SP200194*	30,5	16,7	47,7	47,7
	SP200195*	31,1	20,5	16	47,7
	SP200196*	31,1	23,7	18,8	47,3

1b. Gas nozzle, short lens		mm			
No.	Ordering code	a	b	c	d
4	7990779	18.5	10.5	7	25.5
5	7990780	18.5	12	8	25.5
6	7990781	18.5	13.5	9.5	25.5
7	7990782	18.5	15	11	25.5
8	SP016562	18.5	16.5	12.5	25.5

1c. Gas nozzle, glass		mm		
	Ordering code	a	c	d
Straight	SP015847	19.9	14.8	32.5

1d. Gas nozzle, glass		mm			
	Ordering code	a	b	c	d
15/20 mm	SP015848	20.2	25.3	21	28.3

2. Mesh	
	SP015851

3a. Collet body, lens	
ø 1.6	7990711
ø 2.4	7990712
ø 3.2	7990713
ø 4.0	7990714

3b. Collet body, short lens	
ø 1.6	SP015842
ø 2.4	SP015843
ø 3.2	SP015844
ø 4.8	SP022653*

4. O-ring, gas nozzle, glass	
	SP009746

5a. Collet	
ø 1.6	9876867
ø 2.4	9876868
ø 3.2	9876869
ø 4.0	9876870
ø 4.0	SP021459* (HD)
ø 4.8	SP022418* (HD)

5b. Collet, short	
ø 1.6	7990655
ø 2.4	7990656
ø 3.2	7990657

6a. Insulator	
	9876860

6b. Insulator	
	SP015849
	SP200193*

7. Insulator	
	SP9580266

8. Torch body	
See suitability from torch bodies compatibility table on page 85.	

9. Insulator	
	SP9580267

10. O-ring	
	SP7990791

11. Back cap		Length (mm)
Small	7990731	26
Medium	7990735	58
Long	7990741	120

Electrode		
Grey	ø 1.6	9873532
	ø 2.4	9873533
	ø 3.2	9873534
	ø 4.0	9873535
White	ø 1.6	9873521
	ø 2.4	9873522
	ø 3.2	9873523
Green	ø 4.0	9873524
	ø 4.0	9873505
Grey	ø 4.8	SP200201*
Length of all electrodes 175 mm		

Electrode sharpened 22,5 deg		
Grey	ø 2.4	9873536
Grey	ø 3.2	9873537
Length of all electrodes 85 mm		

* JUMBO / HD consumables, for TX 455 only

TIG Consumable kits

Kemppi Flexlite TIG Consumable Kits include a complete set of consumables for your TIG welding applications. Kits provide all TIG torch accessories you need to start welding. They include multiple size nozzles, glass nozzles, lenses, collets and collet bodies ready to be used with small or large torch bodies.

The consumables are packaged within a sturdy, reusable case, which can be used to store all the essential consumables for Flexlite TIG welding torches. The label on the cover shows the product codes, which makes it easier to order more consumables.

By selecting Kemppi TIG consumables you will receive the durability and performance that you need.

TG16S001	TIG CONSUMABLE KIT S 1.6 LENS	Qty
7990636	COLLET 1,6 S	6
7990701	COLLET BODY LENS 1,6 S	3
7990730	BACK CAP SHORT S	1
7990734	BACK CAP MEDIUM S	1
7990740	BACK CAP LONG S	1
SP9878013	INSULATOR S	2
9873532	ELECTRODE GREY 1,6X175 (WC20)	3
7990780	GAS NOZZLE LENS 5 S	2
7990781	GAS NOZZLE LENS 6 S	2
SP015847	GAS NOZZLE GLASS STRAIGHT	1
SP015848	GAS NOZZLE GLASS 15/19,2MM	1
SP009746	O-RING 9,5 x 1,78	6
SP015851	MESH FOR GAS NOZZLE, GLASS	2
TG24S002	TIG CONSUMABLE KIT S 2.4 LENS	Qty
7990637	COLLET 2,4 S	6
7990702	COLLET BODY LENS 2,4 S	3
7990730	BACK CAP SHORT S	1
7990734	BACK CAP MEDIUM S	1
7990740	BACK CAP LONG S	1
SP9878013	INSULATOR S	2
9873533	ELECTRODE GREY 2,4X175 (WC20)	3
7990781	GAS NOZZLE LENS 6 S	2
7990782	GAS NOZZLE LENS 7 S	2
SP015848	GAS NOZZLE GLASS 15/19,2MM	1
SP015847	GAS NOZZLE GLASS STRAIGHT	1
SP009746	O-RING 9,5 x 1,78	6
SP015851	MESH FOR GAS NOZZLE, GLASS	2

TG16L003	TIG CONSUMABLE KIT L 1.6 LENS SHORT	Qty
7990655	COLLET SHORT 1,6 L	6
SP015842	COLLET BODY, LENS SHORT 1,6 L	3
7990731	BACK CAP SHORT L	1
7990735	BACK CAP MEDIUM L	1
7990741	BACK CAP LONG L	1
SP9580267	INSULATOR UPPER L	2
SP015849	INSULATOR SPECIAL L	2
9873532	ELECTRODE GREY 1,6X175 (WC20)	3
7990780	GAS NOZZLE LENS 5 S	2
7990781	GAS NOZZLE LENS 6 S	2
SP015847	GAS NOZZLE GLASS STRAIGHT	1
SP015848	GAS NOZZLE GLASS 15/19,2MM	1
SP009746	O-RING 9,5 x 1,78	6
SP015851	MESH FOR GAS NOZZLE, GLASS	2
TG24L004	TIG CONSUMABLE KIT L 2.4 LENS SHORT	Qty
7990656	COLLET SHORT 2,4 L	6
SP015843	COLLET BODY, LENS SHORT 2,4 L	3
7990731	BACK CAP SHORT L	1
7990735	BACK CAP MEDIUM L	1
7990741	BACK CAP LONG L	1
SP9580267	INSULATOR UPPER L	2
SP015849	INSULATOR SPECIAL L	2
9873533	ELECTRODE GREY 2,4X175 (WC20)	3
7990781	GAS NOZZLE LENS 6 S	2
7990782	GAS NOZZLE LENS 7 S	2
SP015848	GAS NOZZLE GLASS 15/19,2MM	1
SP015847	GAS NOZZLE GLASS STRAIGHT	1
SP009746	O-RING 9,5 x 1,78	6
SP015851	MESH FOR GAS NOZZLE, GLASS	2



TG32L005	TIG CONSUMABLE KIT L 3.2 LENS SHORT	Qty
7990657	COLLET SHORT 3,2 L	6
SP015844	COLLET BODY, LENS SHORT 3,2 L	3
7990731	BACK CAP SHORT L	1
7990735	BACK CAP MEDIUM L	1
7990741	BACK CAP LONG L	1
SP9580267	INSULATOR UPPER L	2
SP015849	INSULATOR SPECIAL L	2
9873534	ELECTRODE GREY 3,2X175 (WC20)	3
7990782	GAS NOZZLE LENS 7 S	2
SP016562	GAS NOZZLE LENS 8 S-L	2
SP015848	GAS NOZZLE GLASS 15/19,2MM	1
SP015847	GAS NOZZLE GLASS STRAIGHT	1
SP009746	O-RING 9,5 x 1,78	6
SP015851	MESH FOR GAS NOZZLE, GLASS	2
TG16L006	TIG CONSUMABLE KIT L 1.6 LENS LONG	Qty
9876867	COLLET 1,6 L	6
7990711	COLLET BODY LENS 1,6 L	3
7990731	BACK CAP SHORT L	1
7990735	BACK CAP MEDIUM L	1
7990741	BACK CAP LONG L	1
SP9580267	INSULATOR UPPER L	2
SP9580266	INSULATOR LOWER L	2
9876860	INSULATOR LENS L	2
9873532	ELECTRODE GREY 1,6X175 (WC20)	3
7990783	GAS NOZZLE LENS 5 L	2
7990784	GAS NOZZLE LENS 6 L	2
7990785	GAS NOZZLE LENS 7 L	2

TG24L007	TIG CONSUMABLE KIT L 2.4 LENS LONG	Qty
9876868	COLLET 2,4 L	6
7990712	COLLET BODY LENS 2,4 L	3
7990731	BACK CAP SHORT L	1
7990735	BACK CAP MEDIUM L	1
7990741	BACK CAP LONG L	1
SP9580267	INSULATOR UPPER L	2
SP9580266	INSULATOR LOWER L	2
9876860	INSULATOR LENS L	2
9873533	ELECTRODE GREY 2,4X175 (WC20)	3
7990784	GAS NOZZLE LENS 6 L	2
7990785	GAS NOZZLE LENS 7 L	2
7990786	GAS NOZZLE LENS 8 L	2
SP009746	O-RING 9,5 x 1,78	6
SP015851	MESH FOR GAS NOZZLE, GLASS	2
TG32L008	TIG CONSUMABLE KIT L 3.2 LENS LONG	Qty
9876869	COLLET 3,2 L	6
7990713	COLLET BODY LENS 3,2 L	3
7990731	BACK CAP SHORT L	1
7990735	BACK CAP MEDIUM L	1
7990741	BACK CAP LONG L	1
SP9580267	INSULATOR UPPER L	2
SP9580266	INSULATOR LOWER L	2
9876860	INSULATOR LENS L	2
9873534	ELECTRODE GREY 3,2X175 (WC20)	3
7990784	GAS NOZZLE LENS 6 L	2
7990785	GAS NOZZLE LENS 7 L	2
7990786	GAS NOZZLE LENS 8 L	2

TIG Consumable kits

W022256	TIG 2.4 LENS KIT L	Qty
7990731	BACK CAP SHORT L	1
9876868	COLLET 2,4 L	1
7990712	COLLET BODY LENS 2,4 L	1
9876860	INSULATOR LENS L	1
7990786	GAS NOZZLE LENS 8 L	1

W017119	TIG 3.2 LENS KIT L	Qty
7990731	BACK CAP SHORT L	1
9876869	COLLET 3,2 L	1
7990713	COLLET BODY LENS 3,2 L	1
9876860	INSULATOR LENS L	1
7990786	GAS NOZZLE LENS 8 L	1

W016085	PRO KIT 5/16-24	Qty
7990635	COLLET 1,0 S	3
7990636	COLLET 1,6 S	3
7990637	COLLET 2,4 S	3
SP9878013	INSULATOR S	3
7990730	BACK CAP SHORT S	1
7990734	BACK CAP MEDIUM S	1
7990740	BACK CAP MEDIUM L	1
7990700	COLLET BODY LENS 1,0 S	1
7990701	COLLET BODY LENS 1,6 S	1
7990702	COLLET BODY LENS 2,4 S	1
7990779	GAS NOZZLE LENS 4 S-L	1
7990780	GAS NOZZLE LENS 5 S-L	1
7990781	GAS NOZZLE LENS 6 S-L	1
7990782	GAS NOZZLE LENS 7 S-L	1
SP015847	GAS NOZZLE GLASS STRAIGHT	2
SP015848	GAS NOZZLE GLASS 15/20MM	2
SP009746	O-RING 9,5 x 1,78	4
SP015851	MESH FOR GAS NOZZLE, GLASS	2

W016086	PRO KIT 3/8-32	Qty
7990780	GAS NOZZLE LENS 5 S	1
7990781	GAS NOZZLE LENS 6 S	1
7990782	GAS NOZZLE LENS 7 S	1
7990779	GAS NOZZLE LENS 4 S	1
7990655	COLLET SHORT 1,6 L	3
7990656	COLLET SHORT 2,4 L	3
7990657	COLLET SHORT 3,2 L	3
SP015842	COLLET BODY LENS SHORT 1,6 L	1
SP015843	COLLET BODY LENS SHORT 2,4 L	1
SP015844	COLLET BODY LENS SHORT 3,2 L	1
SP9580267	INSULATOR UP L	1
SP015849	INSULATOR SPECIAL L	2
7990731	BACK CAP SHORT L	1
7990735	BACK CAP MEDIUM L	1
7990741	BACK CAP LONG L	1
SP015847	GAS NOZZLE GLASS STRAIGHT	2
SP015848	GAS NOZZLE GLASS 15/20MM	2
SP009746	O-RING 9,5 x 1,78	4
SP015851	MESH FOR GAS NOZZLE, GLASS	2

Ordering information

FLEXLITE TX				
Product	Ordering code			
	4 m:	8 m:	16 m:	25 m:
FLEXLITE TX 133GF	-	TX133GF8	-	
FLEXLITE TX 135GF	TX135GF4	TX135GF8	TX135GF16	
FLEXLITE TX 163GF	-	TX163GF8	-	
FLEXLITE TX 165GF	TX165GF4	TX165GF8	TX165GF16	
FLEXLITE TX 225 GFL	TX225GFL4	TX225GFL8	-	-
FLEXLITE TX 225 GF	-	TX225GF8	-	-
FLEXLITE TX 255 WFL	TX255WFL4	TX255WFL8	TX255WFL16	
FLEXLITE TX 163GS	TX163GS4	TX163GS8	-	
FLEXLITE TX 165GS	TX165GS4	TX165GS8	TX165GS16	
FLEXLITE TX 165G	TX165G4	TX165G8	TX165G16	
FLEXLITE TX 223G	TX223G4	TX223G8	-	
FLEXLITE TX 223GE	TX223GE4	-	-	
FLEXLITE TX 225G	TX225G4	TX225G8	TX225G16	
FLEXLITE TX 223GS	-	TX223GS8	TX223GS16	
FLEXLITE TX 225GS	TX225GS4	TX225GS8	TX225GS16	
FLEXLITE TX 303WFL	-	TX303WF8	-	
FLEXLITE TX 305WFL	TX305WF4	TX305WF8	TX305WF16	TX305WF25
FLEXLITE TX 305W	TX305W4	TX305W8	-	-
FLEXLITE TX 253WS	TX253WS4	TX253WS8	-	
FLEXLITE TX 253WSE	TX253WSE4	-	-	
FLEXLITE TX 255WS	TX255WS4	TX255WS8	TX255WS16	
FLEXLITE TX 353W	TX353W4	TX353W8	TX353W16	
FLEXLITE TX 353WE	TX353WE4	-		
FLEXLITE TX 355W	TX355W4	TX355W8	TX355W16	
FLEXLITE TX 133GF	-	TX135GF8	-	
FLEXLITE TX 135GFN	TX135GFN4	TX135GFN8	-	
FLEXLITE TX 163GVD9	TX163GVD94	-	-	
FLEXLITE TX 165GFN	TX165GFN4	TX165GFN8	-	
FLEXLITE TX 165GSN	-	TX165GSN8	-	
FLEXLITE TX 223 GVD13	TX223GVD134	-	-	
FLEXLITE TX 225GN	TX225GN4	TX225GN8	-	
FLEXLITE TX 255WSN	-	TX255WSN8	-	
FLEXLITE TX 305WFN	-	TX305WFN8	-	
FLEXLITE TX 355WN	-	TX355WN8	-	
FLEXLITE TX 455W	TX455W4	TX455W8		

FLEXLiTE TX remotes (optional, available for Series 5 models only)

Product	Ordering code	
	For water-cooled torch:	For gas-cooled torch:
FLEXLiTE TXR10 remote, roller switch	TXR10W	TXR10G
FLEXLiTE TXR20 remote, rocker switch	TXR20W	TXR20G

FLEXLiTE TX other accessories (optional)

Product	Ordering code
FLEXLiTE TX trigger extension	SP801091
Adapter G1/4 to DIX 9mm	SP016758
Adapter G1/4 to DIX 13mm	SP016759



Adapter G1/4 to DIX 9mm



Adapter G1/4 to DIX 13mm

The name of a Flexlite torch tells its properties and use

Model series name

Power rating

Kemppi series:

3 or 5

Cooling type:

G = Gas

W = Water

Technical features:

S = S neck

F = Flexible neck

FL = Flexible locking

N = No switch

V = Gas valve

E = Euro connector

D9 = DIX 9 mm

D13 = DIX 13 mm

TX

160 A = 16

5

G

FN

TX165GFN

THE FORERUNNER OF ARC WELDING

Kemppi is the design leader of the arc welding industry. We are committed to boosting the quality and productivity of welding by continuous development of the welding arc. Kemppi supplies advanced products, digital solutions and services for professionals from industrial welding companies to single contractors. The usability and reliability of our products is our guiding principle. We operate with a highly skilled partner network covering over 70 countries to make its expertise locally available. Headquartered in Lahti, Finland, Kemppi employs close to 800 professionals in 17 countries and has a revenue of 178 MEUR.

Kemppi – Designed for welders

www.kemppi.com |       

